

Concealed ceiling unit
with high ESP
Air Conditioning
Technical Data
FXMA-A

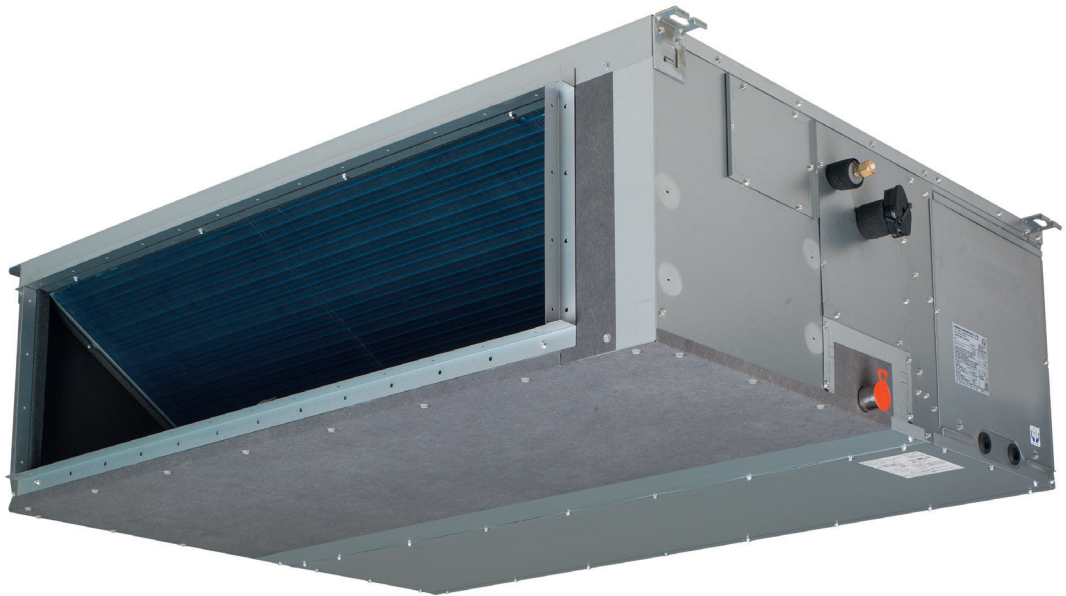

FXMA50A5VEB
FXMA63A5VEB
FXMA80A5VEB
FXMA100A5VEB
FXMA125A5VEB
FXMA200AXVMB
FXMA250AXVMB

TABLE OF CONTENTS

FXMA-A

1	Features	4
	FXMA-A	4
2	Specifications	5
3	Safety device settings	9
4	Options	10
5	Capacity tables	11
	Cooling/Heating Capacity Tables	11
6	Dimensional drawings	12
7	Centre of gravity	14
8	Piping diagrams	15
9	Wiring diagrams	17
	Wiring Diagrams - Single Phase	17
10	Sound data	19
	Sound Power Spectrum	19
	Sound Pressure Spectrum	23
11	Fan characteristics	27

1 Features

1 - 1 FXMA-A

Ideal for large sized spaces ESP up to 270 Pa

1

- > Optimised design for R-32 refrigerant
- > High external static pressure up to 200Pa facilitates extensive duct and grille network
- > Possibility to change ESP via wired remote control allows optimisation of the supply air volume
- > Discretely concealed in the wall: only the suction and discharge grilles are visible
- > Large capacity unit: up to 31.5 kW heating capacity

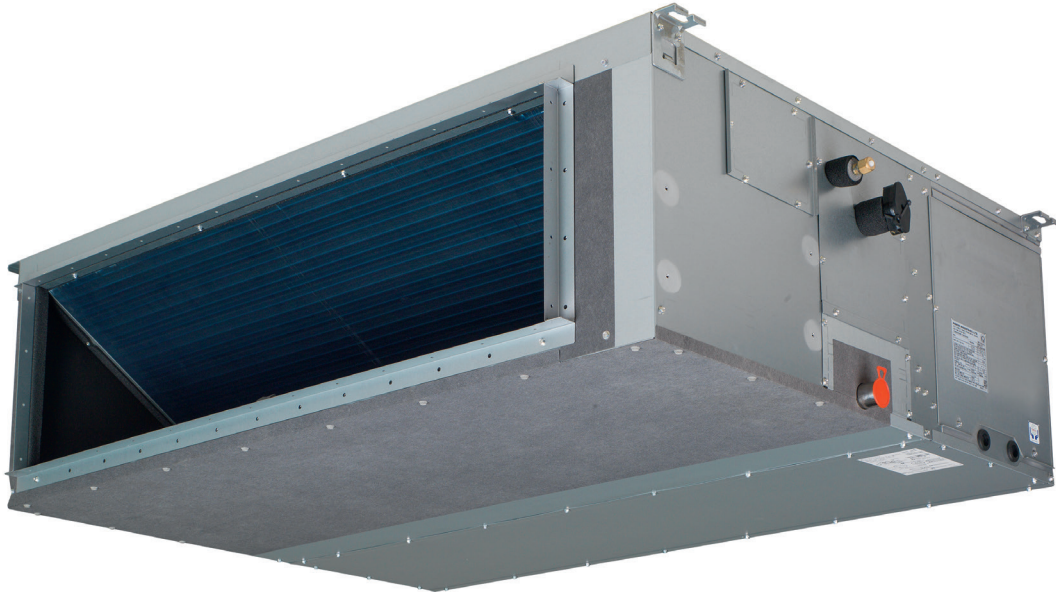

Onecta app (optional)
(optional)



Home leave operation



Fan only



Auto cooling-heating changeover



Fan speed steps (FXMA50-125: 3 steps; FXMA200-250: 3 steps + auto)



Dry programme



Air filter (pre filter)



Weekly timer (optional)



Infrared remote control (optional - must be combined with Madoka wired remote controller)



Wired remote control (optional)



Centralised control (optional)



Auto-restart



Self diagnosis



Drain pump kit

2 Specifications

1 - 1 FXMA-A

Technical specifications				FXMA50A	FXMA63A	FXMA80A	FXMA100A	FXMA125A	
Cooling capacity	Sensible capacity	At high fan speed	kW	4.0	5.1	6.7	8.1	10.3	
		At medium fan speed	kW	3.4	4.2	5.6	6.3	8.4	
		At low fan speed	kW	2.9	3.4	4.0	4.2	6.6	
	Latent capacity	At high fan speed	kW	1.6	2.0	2.3	3.1	3.7	
		At medium fan speed	kW	1.3	1.6	1.9	2.4	3.0	
		At low fan speed	kW	1.1	1.3	1.4	1.6	2.4	
Total capacity	At high fan speed	kW	5.6	7.1	9.0	11.2	14.0		
	At medium fan speed	kW	4.7	5.8	7.5	8.7	11.4		
	At low fan speed	kW	4.0	4.7	5.4	5.8	9.0		
Heating capacity	Total capacity	At high fan speed	kW	6.3	8.0	10.0	12.5	16.0	
		At medium fan speed	kW	5.1	6.3	8.3	9.3	12.8	
		At low fan speed	kW	4.1	5.0	5.9	6.0	9.8	
Power input - 50Hz	Cooling	At high fan speed	kW	0.125	0.140	0.198	0.191	0.254	
		At medium fan speed	kW	0.100	0.106	0.150	0.121	0.162	
		At low fan speed	kW	0.079	0.085	0.110	0.082	0.107	
	Heating	At high fan speed	kW	0.125	0.140	0.198	0.191	0.254	
		At medium fan speed	kW	0.100	0.106	0.150	0.121	0.162	
		At low fan speed	kW	0.079	0.085	0.110	0.082	0.107	
Power input - 60Hz	Cooling	At high fan speed	kW	0.125	0.140	0.198	0.191	0.254	
	Heating	At high fan speed	kW	0.125	0.140	0.198	0.191	0.254	
Dimensions	Unit	Height	mm	300					
		Width	mm	1,000		1,400			
		Depth	mm	700					
	Packed unit	Height	mm	355					
		Width	mm	1,220		1,620			
		Depth	mm	900					
Weight	Unit	kg	35			46			
	Packed unit	kg	39			49			
Casing	Colour	Unpainted							
	Material	Galvanised steel plate							
Required ceiling void >		mm	350						
Heat exchanger	Inside length	mm	740			1,140			
	Rows	Quantity	3						
	Fin pitch	mm	1.75						
	Passes	Quantity	7			11			
	Face area	m ²	0.249			0.383			
Heat exchanger	Stages	Quantity	16						
	Empty tubeplate hole	Quantity	0						
	Tube type	ø7 Hi-XD							
	Fin	Type	MLH7 Fin (Hydrophilia)						
Fan	Type	Sirocco fan							
	Quantity	2			3				
	Air flow rate - 50Hz	Cooling	At high fan speed	m ³ /min	18.0	19.5	25.0	32.0	36.0
			At medium fan speed	m ³ /min	16.5	17.5	22.5	27.0	30.0
			At low fan speed	m ³ /min	15.0	16.0	20.0	23.0	26.0
		Heating	At high fan speed	m ³ /min	18.0	19.5	25.0	32.0	36.0
			At medium fan speed	m ³ /min	16.5	17.5	22.5	27.0	30.0
			At low fan speed	m ³ /min	15.0	16.0	20.0	23.0	26.0
	Air flow rate - 60Hz	Cooling	At high fan speed	cfm	636	689	883	1,130	1,271
			At medium fan speed	cfm	583	618	795	953	1,059
			At low fan speed	cfm	530	565	706	812	918
		Heating	At high fan speed	cfm	636	689	883	1,130	1,271
			At medium fan speed	cfm	583	618	795	953	1,059
			At low fan speed	cfm	530	565	706	812	918
	External static pressure - 50Hz	Factory set	Pa	100					
High		Pa	200						
Factory set		Pa	100						
High		Pa	200						
External static pressure - 60Hz	Factory set	Pa	100						
	High	Pa	200						
	Factory set	Pa	100						
	High	Pa	200						
Fan motor	Drive	Direct drive							

2 Specifications

1 - 1 FXMA-A

2

Technical specifications				FXMA50A	FXMA63A	FXMA80A	FXMA100A	FXMA125A
Sound power level	Cooling	At high fan speed	dBa	61.0	64.0	67.0	65.0	70.0
		At medium fan speed	dBa	60.0	61.0	64.0	61.0	66.0
		At low fan speed	dBa	58.0	59.0	62.0	56.0	62.0
	Heating	At high fan speed	dBa	62.0	65.0	68.0	66.0	71.0
		At medium fan speed	dBa	61.0	62.0	65.0	62.0	67.0
		At low fan speed	dBa	59.0	60.0	63.0	57.0	63.0
Sound pressure level	Cooling	At high fan speed	dBa	41.0	42.0	43.0		44.0
		At medium fan speed	dBa	39.0	40.0	41.0		42.0
		At low fan speed	dBa	37.0	38.0	39.0		40.0
	Heating	At high fan speed	dBa	41.0	42.0	43.0		44.0
		At medium fan speed	dBa	39.0	40.0	41.0		42.0
		At low fan speed	dBa	37.0	38.0	39.0		40.0
Fan motor	Quantity				1			
	Speed	Steps				3		
Fan motor	Output	Max	W	350				
Refrigerant	Type				R-32			
	GWP				675			
	Control				Electronic expansion valve			
Piping connections	Liquid	Type				Flare connection		
		OD	mm	6.35		9.52		
	Gas	Type				Flare connection		
		OD	mm	12.70		15.90		
Drain				VP25 (I.D. 25/O.D. 32)				
Heat insulation				Foamed polystyrene / polyethylene				
Air filter	Type				Resin net			
Safety devices	Item	01				PC board fuse		
		02				Fan motor overcurrent protector		
Control systems	Infrared remote control				BRC4C65 / BRC4C66			
	Wired remote control				BRC1H52W/S/K			

Technical specifications				FXMA200A	FXMA250A	
Cooling capacity	Sensible capacity	At high fan speed	kW	16.4	20.4	
		Nom.	kW	22.4	28.0	
	Sensible capacity	At medium fan speed	kW	13.9	17.5	
Heating capacity	Nom.	kW	25.0	31.5		
Cooling capacity	Sensible capacity	At low fan speed	kW	12.5	15.3	
		Latent capacity	At high fan speed	kW	6.0	7.6
			At medium fan speed	kW	5.1	6.5
	At low fan speed		kW	4.5	5.7	
	Total capacity	At high fan speed	kW	22.4	28.0	
		At medium fan speed	kW	19	24	
At low fan speed		kW	17	21		
Heating capacity	Total capacity	At high fan speed	kW	25.0	31.5	
		At medium fan speed	kW	20.5	27.0	
		At low fan speed	kW	18	22	
Power input - 50Hz	Cooling	At high fan speed	kW	0.54	0.65	
		At medium fan speed	kW	0.258	0.430	
		At low fan speed	kW	0.167	0.246	
	Heating	At high fan speed	kW	0.54	0.65	
		At medium fan speed	kW	0.258	0.430	
		At low fan speed	kW	0.167	0.246	
Power input - 60Hz	Cooling	At high fan speed	kW	0.54	0.65	
	Heating	At high fan speed	kW	0.54	0.65	
Dimensions	Unit	Height	mm	1,143		
		Width	mm	1,572		
		Depth	mm	470		
	Packed unit	Height	mm	1,319		
		Width	mm	1,724		
		Depth	mm	511		
Weight	Unit	kg	105	115		
	Packed unit	kg	124	135		
Casing	Colour				Unpainted	
	Material				Galvanised steel plate	
Heat exchanger	Inside length	mm	1,260			
	Outside length	mm	1,260			
	Rows	Quantity	2	3		
	Fin pitch	mm	1.4			

2 Specifications

1 - 1 FXMA-A

Technical specifications				FXMA200A		FXMA250A	
Heat exchanger	Passes	Quantity				16	
	Face area		m ²			0.85	
	Stages	Quantity				32	
	Empty tubeplate hole	Quantity				0	
	Tube type					ø7 Hi-XU	
	Fin	Type				Raise Lance	
Fan	Type					Sirocco fan	
	Quantity					2	
	Air flow rate - 50Hz	Cooling	At high fan speed	m ³ /min	62		74
			At medium fan speed	m ³ /min	48		64
			At low fan speed	m ³ /min	41		52
		Heating	At high fan speed	m ³ /min	62		74
			At medium fan speed	m ³ /min	48		64
			At low fan speed	m ³ /min	41		52
	Air flow rate - 60Hz	Cooling	At high fan speed	cfm	2,190		2,613
			At medium fan speed	cfm	1,695		2,260
			At low fan speed	cfm	1,448		1,836
		Heating	At high fan speed	cfm	2,190		2,613
			At medium fan speed	cfm	1,695		2,260
			At low fan speed	cfm	1,448		1,836
	External static pressure - 50Hz	Factory set	Pa				150
High		Pa				250	
Low		Pa				50	
External static pressure - 60Hz	Factory set	Pa				150	
	High	Pa				250	
	Low	Pa				50	
Fan motor	Drive					Direct drive	
Sound power level	Cooling	At high fan speed	dB(A)	75		76	
		At medium fan speed	dB(A)	74		75	
		At low fan speed	dB(A)	72		73	
	Heating	At high fan speed	dB(A)	75		76	
		At medium fan speed	dB(A)	74		75	
		At low fan speed	dB(A)	72		73	
Sound pressure level	Cooling	At high fan speed	dB(A)		48		
		At medium fan speed	dB(A)		46.5		
		At low fan speed	dB(A)		45		
Sound pressure level	Heating	At high fan speed	dB(A)		48		
		At medium fan speed	dB(A)		46.5		
Fan motor	Quantity					1	
	Model			DMUD8C4DK		ERC8804ADS	
	Speed	Steps				3	
	Output	Max	W	648		750	
Refrigerant	Type					R-32	
	GWP					675	
	Control					Electronic expansion valve	
Piping connections	Liquid	Type				Flare connection	
		OD	mm			9.5	
	Gas	Type				Flange	
		OD	mm			19.1	
	Drain					BSP1	
Heat insulation					Foamed Polyethylene		
Safety devices	Item	01				PC board fuse	
		02				Fan motor overcurrent protector	
Control systems	Infrared remote control					BRC4C65	
	Wired remote control					BRC1H52W/S/K	

Standard accessories: Installation and operation manual; Quantity: 1;

Standard accessories: Drain hose; Quantity: 1;

Standard accessories: Metal clamp for drain hose; Quantity: 1;

Standard accessories: Washer for hanger bracket; Quantity: 8;

Standard accessories: Screws; Quantity: 16;

Standard accessories: Insulation for fitting; Quantity: 2;

Standard accessories: Sealing pad; Quantity: 3;

2 Specifications

1 - 1 FXMA-A

Standard accessories: Wire clamp material; Quantity: 1;

Standard accessories: Spring washer; Quantity: 2;

Standard accessories: Hexagon head screw; Quantity: 2;

Standard accessories: Plain washer; Quantity: 8;

Standard accessories: Hexagon head screw with washer; Quantity: 49;

2

Electrical specifications		FXMA50A	FXMA63A	FXMA80A	FXMA100A	FXMA125A
Power supply	Name	VE				
	Phase	1~				
	Frequency	50/60				
	Voltage	220-240/220				
Current - 50Hz	Minimum circuit amps (MCA)	1.8	2.0	2.4	3.0	3.2
	Maximum fuse amps (MFA)	6				
	Full load amps (FLA) Total	1.6	1.8	2.2	2.7	2.9
Current - 60Hz	Minimum circuit amps (MCA)	1.8	2.0	2.4	3.0	3.2
	Maximum fuse amps (MFA)	6				
	Full load amps (FLA) Total	1.6	1.8	2.2	2.7	2.9

Electrical specifications		FXMA200A	FXMA250A
Power supply	Name	VE	
	Phase	1~	
	Frequency	50/60	
	Voltage	220-240/220-230	
Current - 50Hz	Minimum circuit amps (MCA)	4.3	5.2
	Maximum fuse amps (MFA)	6	
	Full load amps (FLA) Total	3.9	4.7
Current - 60Hz	Minimum circuit amps (MCA)	4.3	5.2
	Maximum fuse amps (MFA)	6	
	Full load amps (FLA) Total	3.9	4.7

1. Values are valid for the factory setting. |
2. Cooling: indoor temp. 27°CDB, 19°CWB; outdoor temp. 35°CDB; equivalent piping length: 5m; level difference: 0m |
3. Heating: indoor temp. 20°CDB; outdoor temp. 7°CDB, 6°CWB; equivalent refrigerant piping: 5m; level difference: 0m |
4. Capacities are net, including a deduction for cooling (an addition for heating) for indoor fan motor heat. |
5. External static pressure is changeable to set by the remote control (from standard to high, see installation manual) |
6. Voltage range: units are suitable for use on electrical systems where voltage supplied to unit terminal is not below or above listed range limits. |
7. Maximum allowable voltage range variation between phases is 2%. |
8. MCA/MFA: MCA = 1.1 x FLA |
9. Instead of a fuse, use a circuit breaker |
10. Select wire size based on the value of MCA |
11. Contains fluorinated greenhouse gases

3 Safety device settings

3 - 1 Safety Device Settings

FXMA50-125A

Safety devices	FXMA50	FXMA63	FXMA80	FXMA100	FXMA125
Printed circuit board (main)	250V, 3.15A				
Printed circuit board (fan)	250V, 6.3A				

4D139805
FXMA200-250A

Safety devices	FXMA200AXVMB	FXMA250AXVMB
PCB fuse	250V, 3.15A	250V, 3.15A
PCB fuse (fan driver)	250V, 20A	250V, 20A

4D140530

4 Options

4 - 1 Options

4

FXMA50-125A

Option kit	Product name	Availability	
		FXMA50A5VEB FXMA63A5VEB FXMA80A5VEB	FXMA100A5VEB FXMA125A5VEB
Air discharge adaptor for round ducts	KDAJ25K71	✓	
	KDAJ25K140		✓
Infrared remote controller	Heat pump BRC4C65 (2)	✓	✓
	Cooling only BRC4C66 (2)	✓	✓
WLAN adaptor for smartphones	BRP069C51	✓	✓
Wired remote control	BRC1H52W (1)	✓	✓
	BRC1H52S (1)	✓	✓
	BRC1H52K (1)	✓	✓
Intelligent Tablet Controller	DCC601A51	✓	✓
Intelligent touch controller	DCS601C51	✓	✓
Central remote control	DCS302C51	✓	✓
Unified ON/OFF controller	DCS301B51 (7)	✓	✓
Schedule timer	DST301B51	✓	✓
Modbus interface for monitoring and control	RTD-NET	✓	✓
Modbus interface for infrastructure cooling	RTD-10	✓	✓
Modbus interface for retail	RTD-20	✓	✓
Modbus interface for hotel	RTD-HO	✓	✓
KNX interface	KLIC-DI	✓	✓
Intelligent Touch Manager	DCM601A51	✓	✓
Modbus interface	EKMBOX	✓	✓
Daikin PMS interface	DCM010A51	✓	✓
BACnet interface	DMS502A51	✓	✓
LonWorks interface	DMS504B51	✓	✓
External wired temperature sensor	KRCS01-8B	✓	✓
External wireless temperature sensor	K.RSS (4) (5)	✓	✓
	EKEWTSC-1 (6)	✓	✓
Adapter with -4- output signals	EKRP1C14 (3)	✓	✓
Wiring adaptor for electrical appendices	KRP4A52	✓	✓
	KRP2A51	✓	✓
Adapter for keycard and/or window contact connection	BRP7A51 (2) (3)	✓	✓
External control adaptor for outdoor unit	DTA104A61 (3)	✓	✓
Installation box for adaptor PCB	KRP1BC101	✓	✓
Relay PCB	ERP01A50 (3)	✓	✓

- ① Mandatory option
 ② Only possible in combination with remote control ·BRC1H52W/S/K·.
 ③ Requires installation box for adaptor PCB ·KRP1BC101·.
 ④ ·K.RSS· is not an official option. Sales for this option are an SBU responsibility.
 ⑤ This option needs to be ordered together with ·EKEWTSC-1·.
 ⑥ ·EKEWTSC-1· is a wire harness for the connection of option ·K.RSS·.
 ⑦ To mount option ·DCS301B51·, option ·KEK26-1A· is required.

4D138467

FXMA200-250A

Option kit	Product name	Availability	
		FXMA200AXVMB FXMA250AXVMB	
Wireless remote control	BRC4C65 (2)	✓	
Wired remote control	BRC1H52W (1)	✓	
	BRC1H52S (1)	✓	
	BRC1H52K (1)	✓	
Intelligent Tablet Controller	DCC601A51	✓	
Intelligent touch controller	DCS601C51	✓	
Central remote control	DCS302C51	✓	
	DCS302CA61	✓	
Unified ON/OFF controller	DCS301B51 (2)	✓	
	DCS301BA61 (2)	✓	
Intelligent Touch Manager	DCM601A51	✓	
Relay PCB	ERP01A50	✓	
Adapter with -4- output signals	EKRP1C14	✓	
Adapter for keycard and/or window contact connection	BRP7A51 (2)	✓	
Electrical box with earth terminal (-2- blocks)	KJB212AA	✓	
Electrical box with earth terminal (-3- blocks)	KJB311AA	✓	
Wire harness for external wireless temperature sensor	EKEWTSC-1 (3)	✓	
Adaptor for wiring	KRP1C65	✓	
Wiring adaptor for electrical appendices	KRP2A51	✓	
	KRP4A51	✓	
External wired temperature sensor	KRCS01-8B	✓	
External adaptor for outdoor unit (installation on indoor unit)	DTA104A61	✓	
WLAN adaptor for smartphones	BRP069C51 (2)	✓	
Drain pump kit	BDU510B250VM	✓	
High-efficiency filter -65-%	BAFM503A250	✓	
High-efficiency filter -90-%	BAFH504A250	✓	
Filter chamber	BDD500B250	✓	
Long-life replacement filter	BAFL502A250	✓	
Pre-filter	BAFL501A250	✓	
Adaptor for multi-tenant applications	DTA114A61	✓	

- ① Mandatory option
 ② Only possible in combination with remote control ·BRC1H52W/S/K·.
 ③ ·EKEWTSC-1· is a wire harness for the connection of option ·K.RSS·.
 ·K.RSS· is not an official option. Sales for this option are an SBU responsibility.

4D140537

5 Capacity tables

5 - 1 Cooling/Heating Capacity Tables

FXMA50-125A

Cooling

Unit size	Fan speed	Indoor air temperature													
		14,0 [°C WB]		16,0 [°C WB]		18,0 [°C WB]		19,0 [°C WB]		20,0 [°C WB]		22,0 [°C WB]		24,0 [°C WB]	
		TC	SHC	TC	SHC	TC	SHC	TC	SHC	TC	SHC	TC	SHC	TC	SHC
50	H	3,1	2,7	4,0	3,2	5,1	3,8	5,6	4,0	6,2	4,2	7,4	4,5	8,6	4,8
	M	Correction factor -0.84 × H-													
	L	Correction factor -0.71 × H-													
63	H	3,9	3,4	5,1	4,1	6,4	4,9	7,1	5,1	7,8	5,3	9,3	5,7	10,9	6,1
	M	Correction factor -0.82 × H-													
	L	Correction factor -0.66 × H-													
80	H	4,9	4,4	6,5	5,4	8,2	6,4	9,0	6,7	9,9	7,0	11,6	7,5	13,6	7,9
	M	Correction factor -0.83 × H-													
	L	Correction factor -0.60 × H-													
100	H	6,1	5,3	8,1	6,5	10,1	7,7	11,2	8,1	12,3	8,4	14,7	9,1	17,2	9,6
	M	Correction factor -0.78 × H-													
	L	Correction factor -0.52 × H-													
125	H	7,6	6,8	10,1	8,3	12,7	9,8	14,0	10,3	15,4	10,7	18,3	11,6	21,3	12,2
	M	Correction factor -0.81 × H-													
	L	Correction factor -0.64 × H-													

Notes
 1) TC: Total capacity [kW]
 SHC: Sensible heat capacity [kW]
 H: High
 M: Medium
 L: Low
 2) Outdoor temperature
 -35°C DB

Heating

Unit size	Fan speed	Indoor air temperature					
		16,0 [°C DB]	18,0 [°C DB]	20,0 [°C DB]	21,0 [°C DB]	22,0 [°C DB]	24,0 [°C DB]
		TC	TC	TC	TC	TC	TC
50	H	7,4	6,8	6,3	6,0	5,8	5,2
	M	Correction factor -0.81 × H-					
	L	Correction factor -0.65 × H-					
63	H	9,4	8,7	8,0	7,7	7,3	6,7
	M	Correction factor -0.79 × H-					
	L	Correction factor -0.63 × H-					
80	H	11,7	10,8	10,0	9,6	9,2	8,3
	M	Correction factor -0.83 × H-					
	L	Correction factor -0.59 × H-					
100	H	14,6	13,6	12,5	12,0	11,4	10,4
	M	Correction factor -0.74 × H-					
	L	Correction factor -0.48 × H-					
125	H	18,4	17,2	16,0	15,4	14,8	13,6
	M	Correction factor -0.80 × H-					
	L	Correction factor -0.61 × H-					

Notes
 1) TC: Total capacity [kW]
 H: High
 M: Medium
 L: Low
 2) Outdoor temperature
 -7°C DB / -6°C WB

4D139666

FXMA200-250A

Cooling

Unit size	Fan speed	Indoor air temperature													
		14,0 [°C WB]		16,0 [°C WB]		18,0 [°C WB]		19,0 [°C WB]		20,0 [°C WB]		22,0 [°C WB]		24,0 [°C WB]	
		TC	SHC	TC	SHC	TC	SHC	TC	SHC	TC	SHC	TC	SHC	TC	SHC
200	H	12,2	10,9	16,1	13,3	20,3	15,7	22,4	16,4	24,5	17,2	29,0	18,5	33,8	19,7
	M	Correction factor -0.85 × H-													
	L	Correction factor -0.76 × H-													
250	H	15,9	13,9	20,7	16,8	25,6	19,6	28,0	20,4	30,6	21,2	36,0	22,5	41,7	23,6
	M	Correction factor -0.86 × H-													
	L	Correction factor -0.75 × H-													

Notes
 1) TC: Total capacity [kW]
 SHC: Sensible heat capacity [kW]
 H: High
 M: Medium
 L: Low
 2) Outdoor temperature -35°C DB

Heating

Unit size	Fan speed	Indoor air temperature					
		16,0 [°C DB]	18,0 [°C DB]	20,0 [°C DB]	21,0 [°C DB]	22,0 [°C DB]	24,0 [°C DB]
		TC	TC	TC	TC	TC	TC
200	H	28,9	26,9	25,0	24,0	23,1	21,2
	M	Correction factor -0.82 × H-					
	L	Correction factor -0.72 × H-					
250	H	36,4	33,9	31,5	30,3	29,1	26,7
	M	Correction factor -0.86 × H-					
	L	Correction factor -0.70 × H-					

Notes
 1) TC: Total capacity [kW]
 H: High
 M: Medium
 L: Low
 2) Outdoor temperature -7°C DB / -6°C WB

4D140674

6 Dimensional drawings

6 - 1 Dimensional Drawings

6

FXMA50-80A

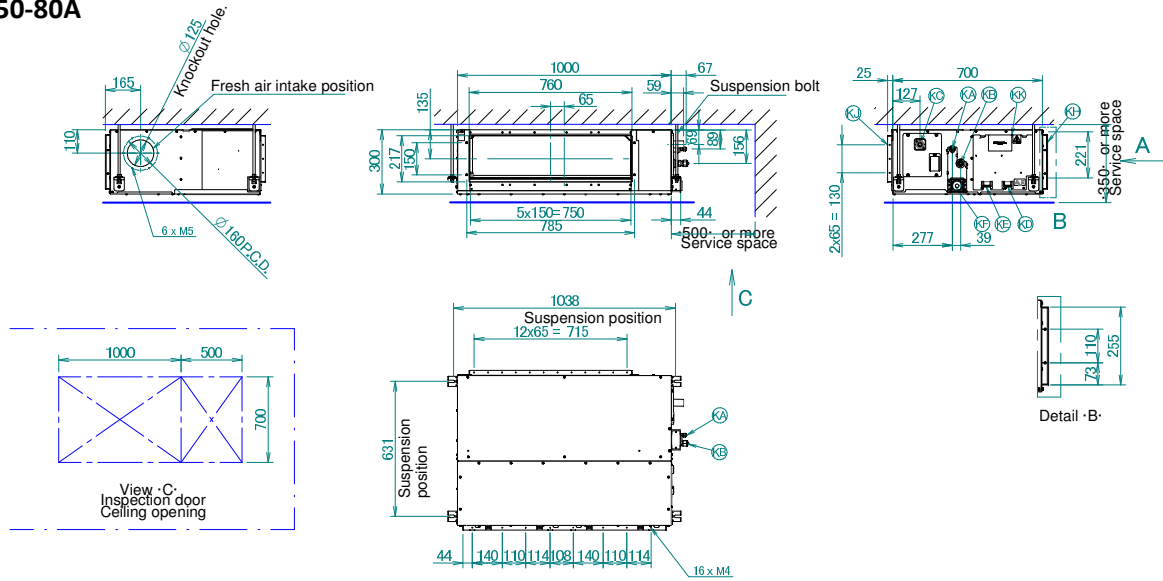

Item	Name	Description
KA	Liquid pipe connection port	Ø6.35" flared connection
KB	Gas pipe connection port	Ø12.70" flared connection
KC	Drain pipe connection	VP25 (OD Ø32, ID Ø25)
KD	Wiring connection	
KE	Power supply connection	
KF	Drain outlet	VP25 (OD Ø32, ID Ø25)
KG	Air filter	
KH	Air suction side	
KJ	Air discharge side	
KK	Nameplate	

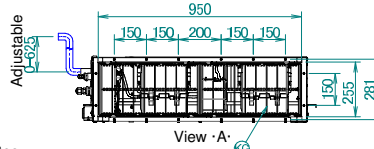

- Notes
1. When installing optional accessories, refer to their respective documentation.
 2. The ceiling depth varies according to the documentation of the specific system.
 3. In case of bottom suction, mount the chamber cover to the backside of the unit.
 4. In case of rear suction, mount the chamber cover to the bottom side of the unit.
- For more information, refer to the installation manual.

3D139544

FXMA100-125A

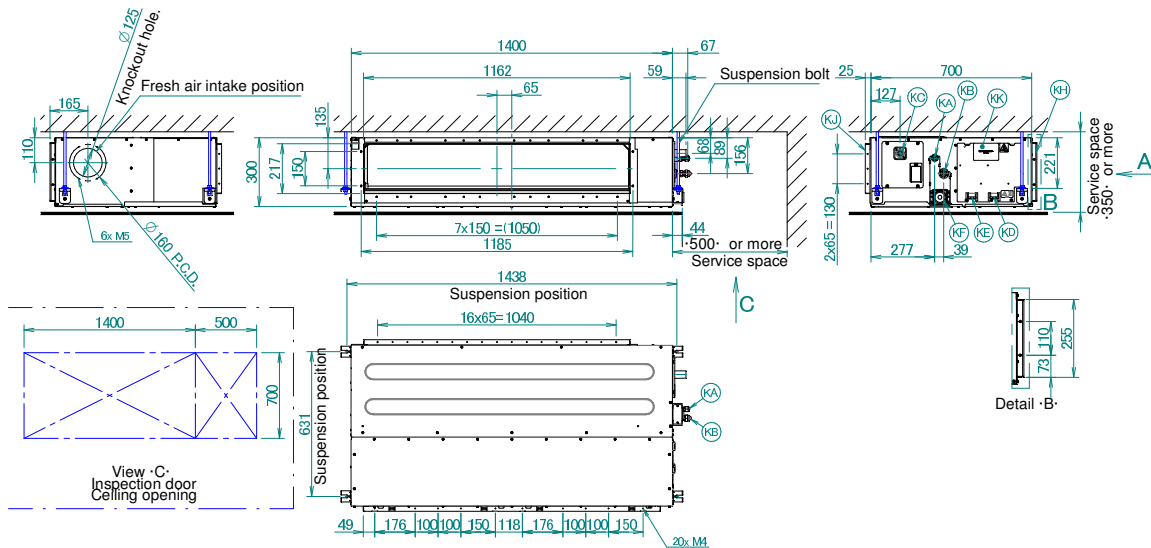

Item	Name	Description
KA	Liquid pipe connection port	Ø9.52" flared connection
KB	Gas pipe connection port	Ø15.90" flared connection
KC	Drain pipe connection	VP25 (OD Ø32, ID Ø25)
KD	Wiring connection	
KE	Power supply connection	
KF	Drain outlet	VP25 (OD Ø32, ID Ø25)
KG	Air filter	
KH	Air suction side	
KJ	Air discharge side	
KK	Nameplate	

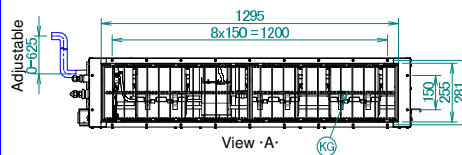

- Notes
1. When installing optional accessories, refer to their respective documentation.
 2. The ceiling depth varies according to the documentation of the specific system.
 3. In case of bottom suction, mount the chamber cover to the backside of the unit.
 4. In case of rear suction, mount the chamber cover to the bottom side of the unit.
- For more information, refer to the installation manual.

3D139547

6 Dimensional drawings

6 - 1 Dimensional Drawings

FXMA200-250A

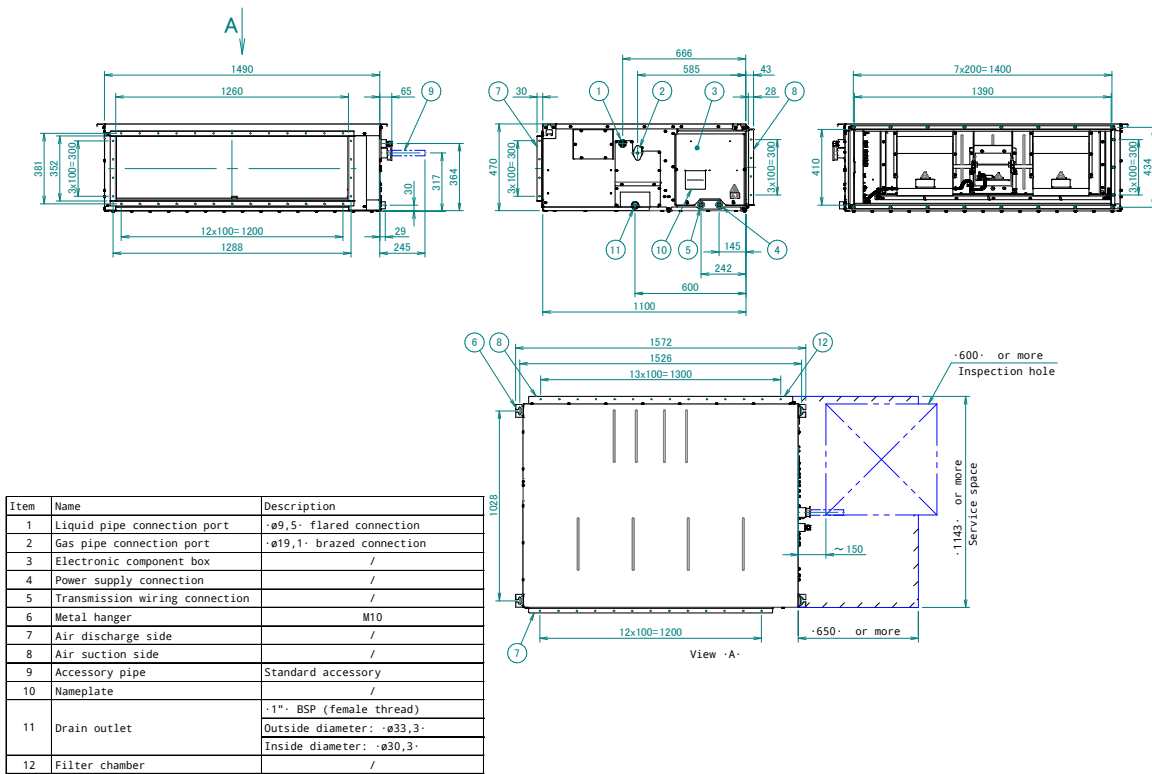

Item	Name	Description
1	Liquid pipe connection port	·ø9,5· flared connection
2	Gas pipe connection port	·ø19,1· brazed connection
3	Electronic component box	/
4	Power supply connection	/
5	Transmission wiring connection	/
6	Metal hanger	M10
7	Air discharge side	/
8	Air suction side	/
9	Accessory pipe	Standard accessory
10	Nameplate	/
11	Drain outlet	·1"· BSP (female thread) Outside diameter: ·ø33,3· Inside diameter: ·ø30,3·
12	Filter chamber	/

Notes
 1. When installing optional accessories, refer to their respective documentation.
 2. The unit nameplate is located on the control box cover.

3D140557

7 Centre of gravity

7 - 1 Centre of Gravity

7

FXMA50-125A

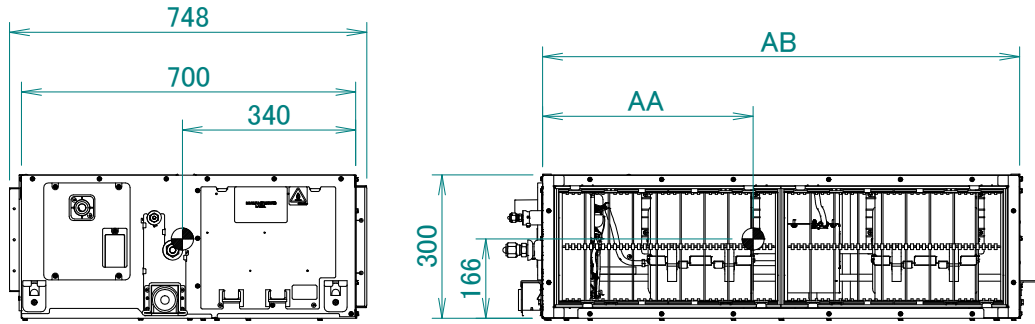

4D137920

FXMA200-250A

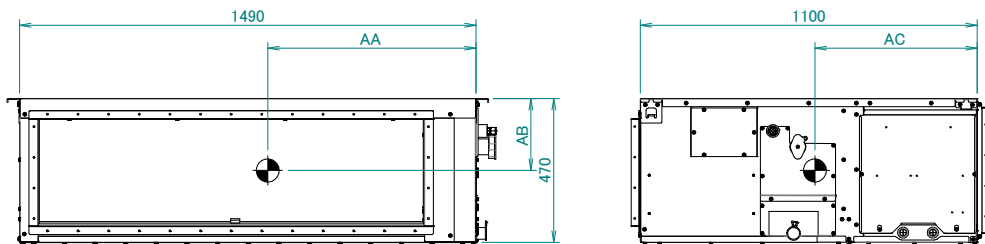

Model name	AA	AB	AC
FXMA200AXVMB	680	235	500
FXMA250AXVMB	700	255	510

3D140474

8 Piping diagrams

8 - 1 Piping Diagrams

FXMA50-125A

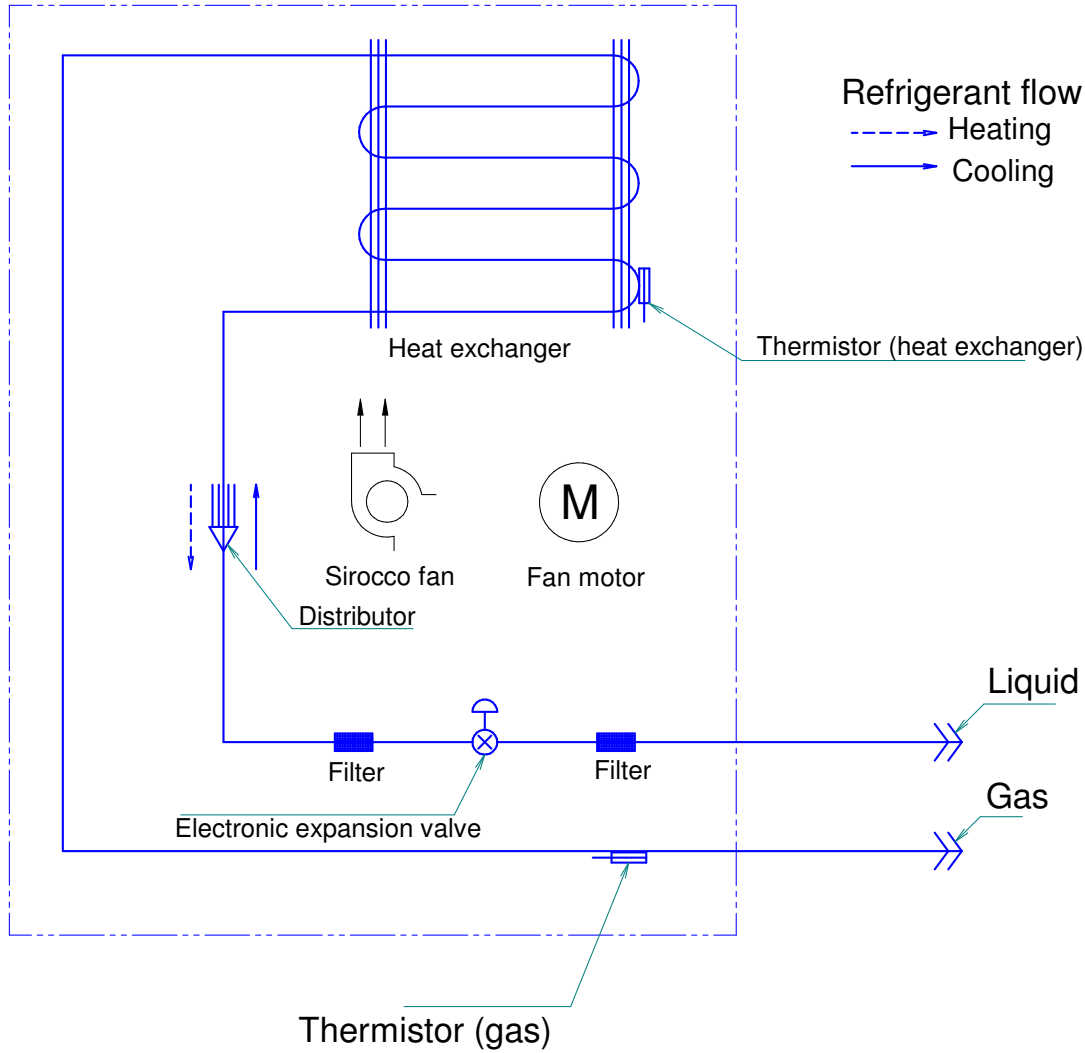

Model	Gas	Liquid
FXMA50/63/80A5VEB	Ø12.70	Ø6.35
FXMA100/125A5VEB	Ø15.90	Ø9.52

4D139220

8 Piping diagrams

8 - 1 Piping Diagrams

8

FXMA200-250A

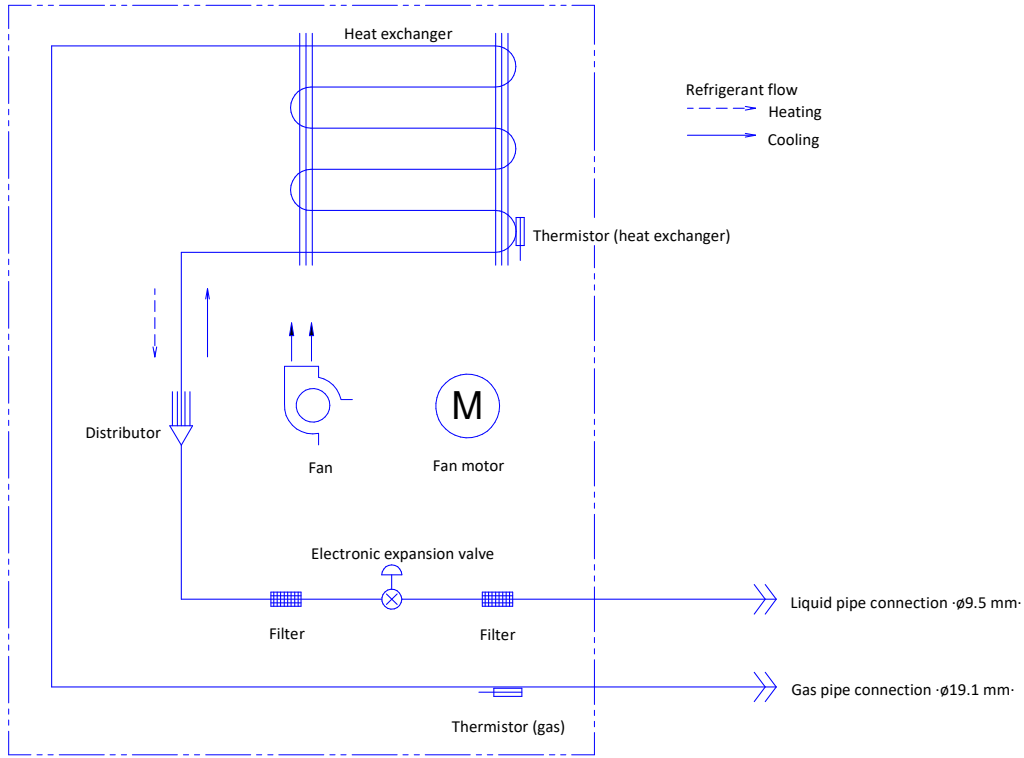

3D140531

9 Wiring diagrams

9 - 1 Wiring Diagrams - Single Phase

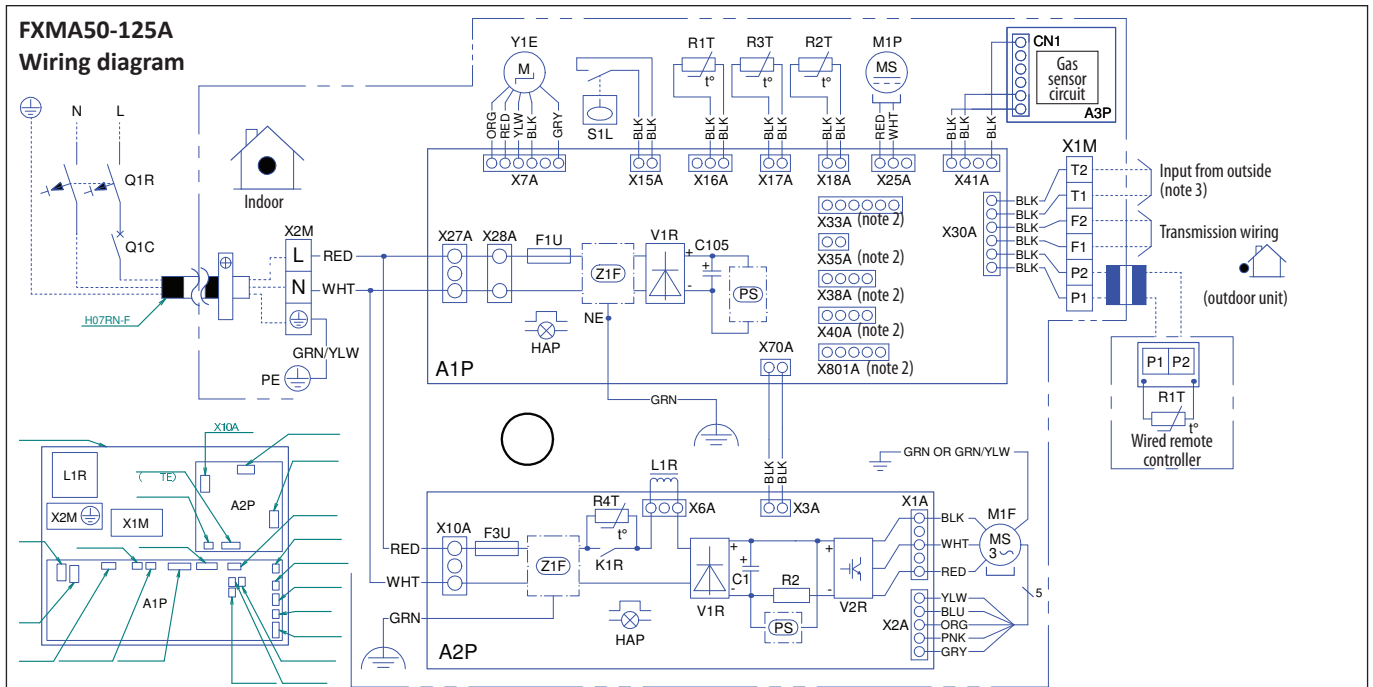

Indoor unit	
A1P	Printed circuit board (main)
A2P	Printed circuit board (fan)
C1	Capacitor
C105	Capacitor
CN1	Gas sensor connector
A3P	Printed circuit board (gas sensor)
F1U	Fuse (T, 3.15A, 250V)
F3U	Fuse (T, 6.3A, 250V)
HAP	Indication lamp
K1R	Magnetic relay
L1R	Reactor
M1F	Motor (indoor fan)
M1P	Motor (drain pump)
NE	Noiseless earth
Q1R	Residual current device
Q1C	Circuit breaker
R2	Resistor (current sensor)
R1T	Thermistor (air)
R2T	Thermistor (liquid)
R3T	Thermistor (coil)
R4T	Thermistor ntc (current limiting)
S1L	Float switch
V1R	Diode bridge
V2R	Power module
PS	Switching power supply
X1M	Terminal strip (control)
X2M	Terminal strip (power supply)
X1A - X801A	Connector
Y1E	Electronic expansion valve
Z1F	Noise filter
	Wired remote controller
R1T	Thermistor (air)

Control box layout

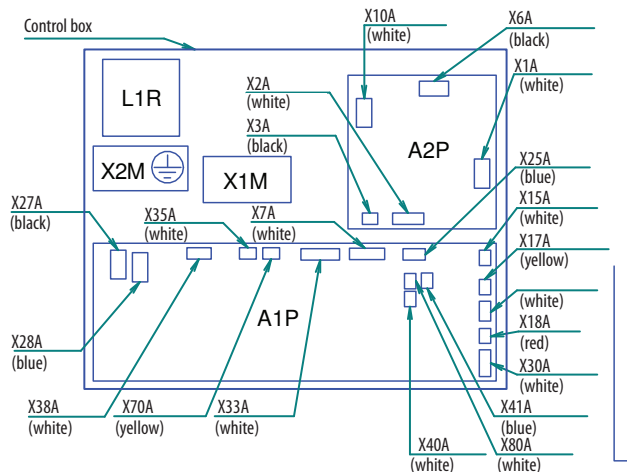

NOTES

- : terminal block, ⊞ : connector, - - - : field wiring
- X33A, X35A, X38A, X40A, X801A are connected when optional accessories are being used, see wiring diagram of this accessory.
- Can be used for fire alarm input only. See installation manual for more information.

WIRE COLORS

- BLK : Black
- BLU : Blue
- YLW : Yellow
- BRN : Brown
- ORG : Orange
- RED : Red
- WHT : White
- GRN : Green
- PNK : Pink
- GRY : Grey

3D137857

9 Wiring diagrams

9 - 1 Wiring Diagrams - Single Phase

9

FXMA200-250A

Wire colors
 BLK : Black
 BLU : Blue
 YLW : Yellow
 BRN : Brown
 ORG : Orange
 RED : Red
 WHT : White
 GRN : Green
 GRY : Grey
 PNK : Pink

Indoor unit

A1P	Printed circuit board (main)
A2P	Printed circuit board (fan)
C1	Capacitor
C105	Capacitor
CN1	Gas sensor connector
A3P	Printed circuit board (gas sensor)
F1U	Fuse (T, 3.15A, 250V)
F3U	Fuse (T, 6.3A, 250V)
HAP	Indication lamp
K1R	Magnetic relay
L1R	Reactor
M1F	Motor (indoor fan)
NE	Noiseless earth
Q1R	Residual current device
Q1C	Circuit breaker
R2	Resistor (current sensor)
R1T	Thermistor (air)
R2T	Thermistor (liquid)
R3T	Thermistor (coil)
R4T	Thermistor NTC (current limiting)
V1R	Diode bridge
V2R	Power module
PS	Switching power supply
X1M	Terminal strip (power supply)
X2M	Terminal strip (control)
X1A - X801A	Connector
Y1E	Electronic expansion valve
Z1F	Noise filter
	Wired remote controller
R1T	Thermistor (air)

NOTES

- Terminal block
- Connector
- Field wiring
- short circuit connector

- X33A, X35A, X38A, X40A, X801A, X15A, X25A Are connected when optional accessories are being used, see wiring diagram of this accessory.
- Can be used for fire alarm input only. See installation manual for more information.
- X15A, X25A Are connected when the drain pump kit is being used. Before installing of drain pump kit remove short circuit connector connected to X15A.

3D139909B

10 Sound data

10 - 1 Sound Power Spectrum

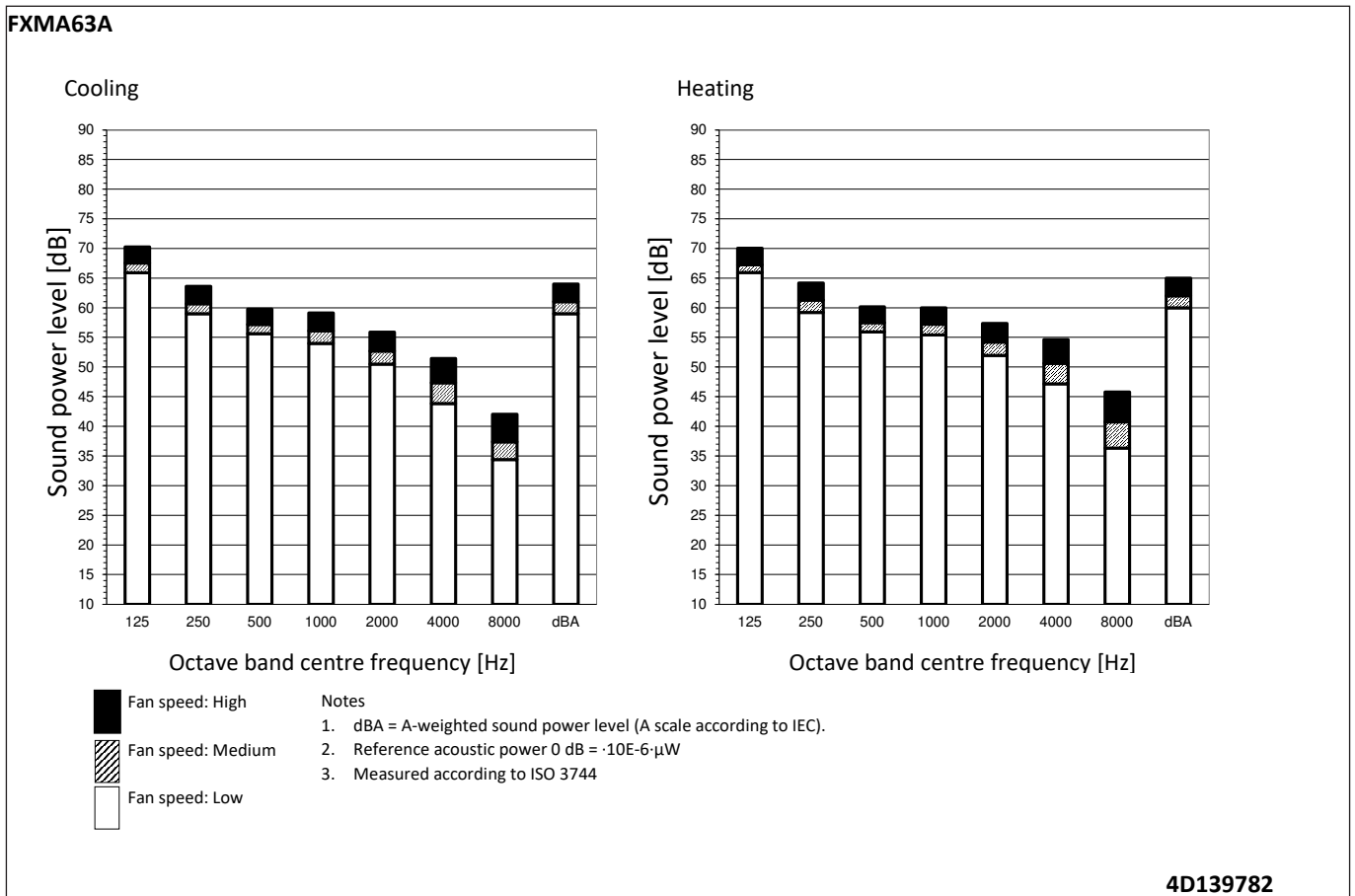
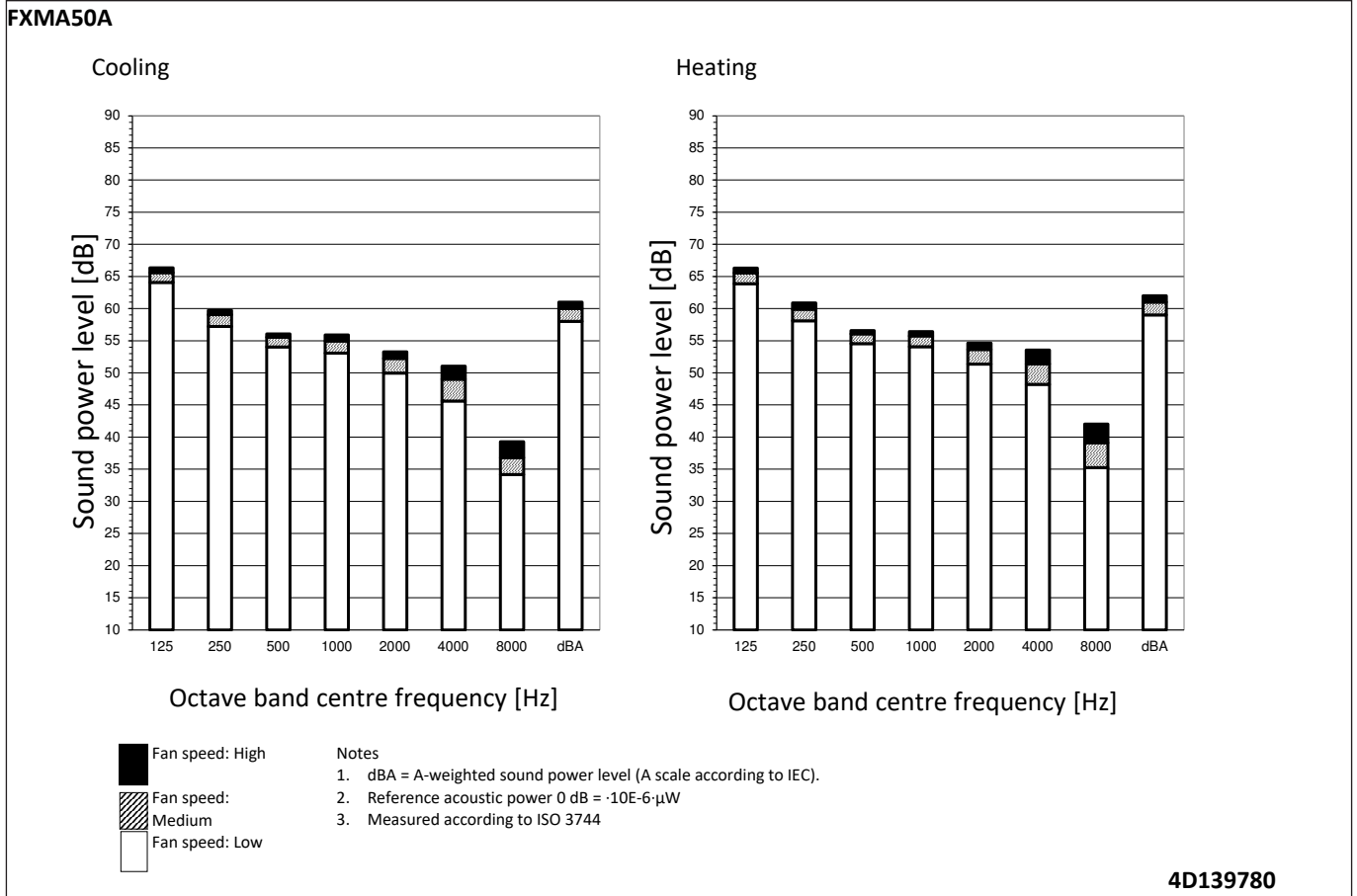

10 Sound data

10 - 1 Sound Power Spectrum

10

FXMA80A

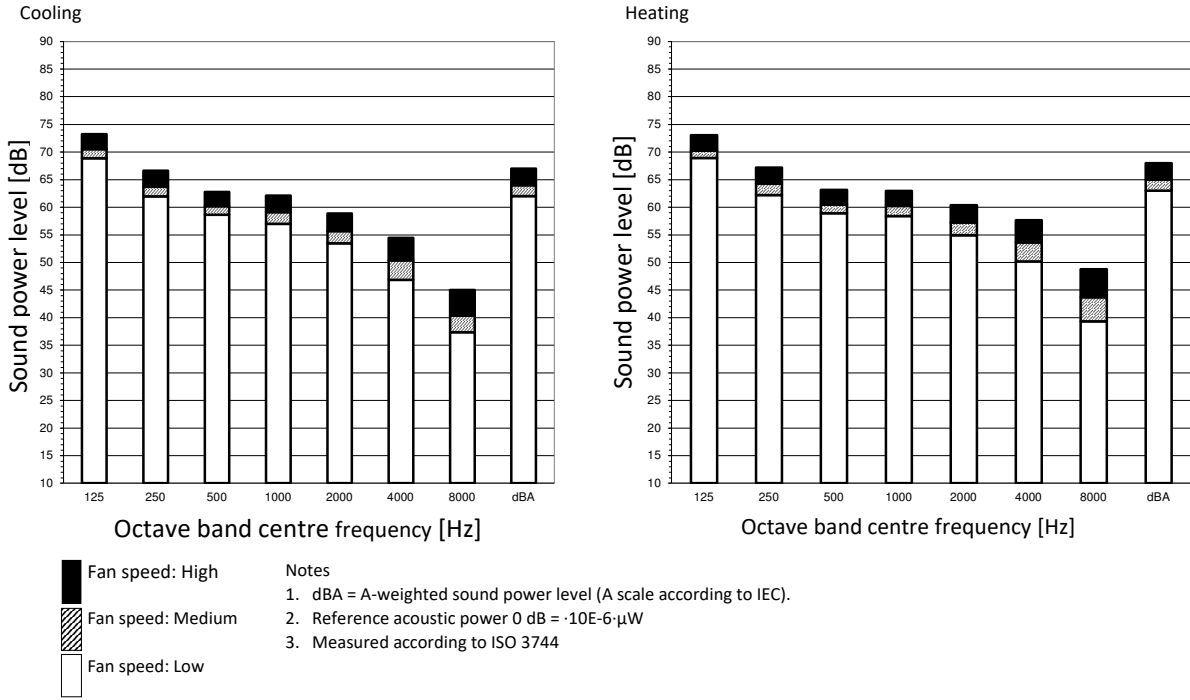

4D139783

FXMA100A

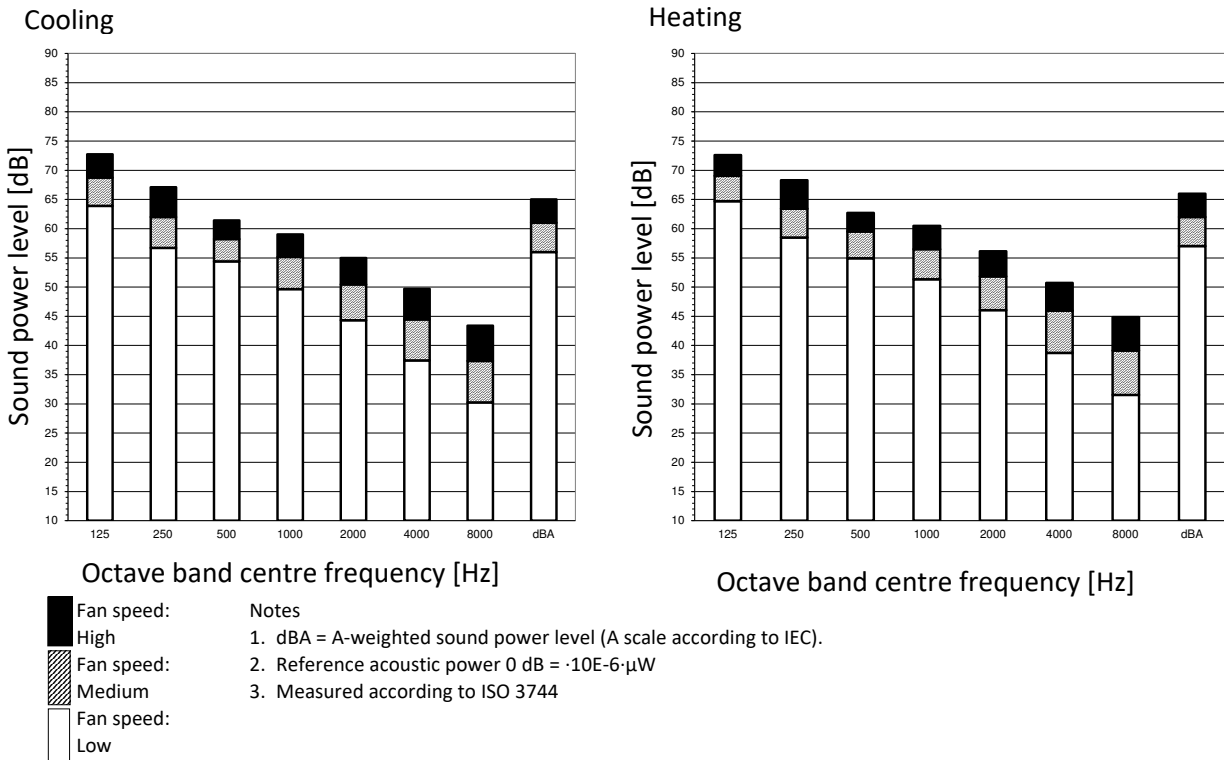

4D139779

10 Sound data

10 - 1 Sound Power Spectrum

FXMA125A

Cooling

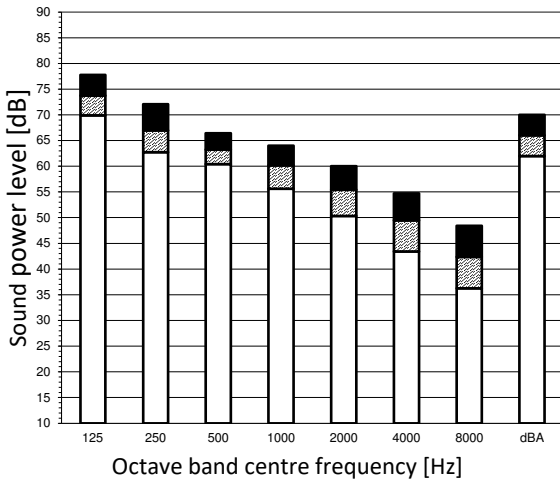

Heating

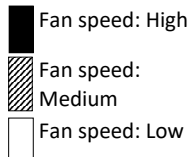
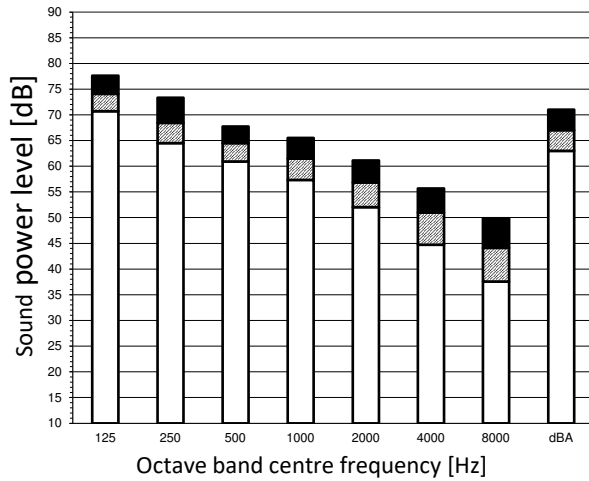

Notes

1. dBA = A-weighted sound power level (A scale according to IEC).
2. Reference acoustic power 0 dB = $-10E-6 \mu W$
3. Measured according to ISO 3744

4D139776

FXMA200A

Cooling

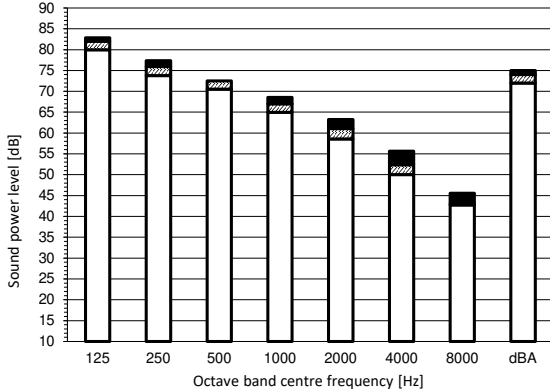

Heating

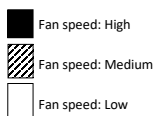
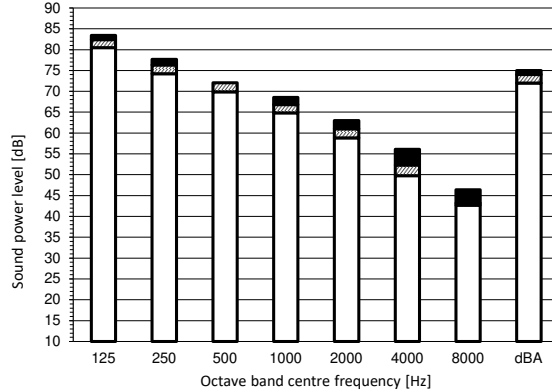

Notes

1. dBA = A-weighted sound power level (A scale according to IEC).
2. Reference acoustic power 0 dB = $-10E-6 \mu W$
3. Measured according to ISO 3744

4D140664

10 Sound data

10 - 1 Sound Power Spectrum

10

FXMA250A

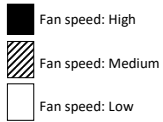
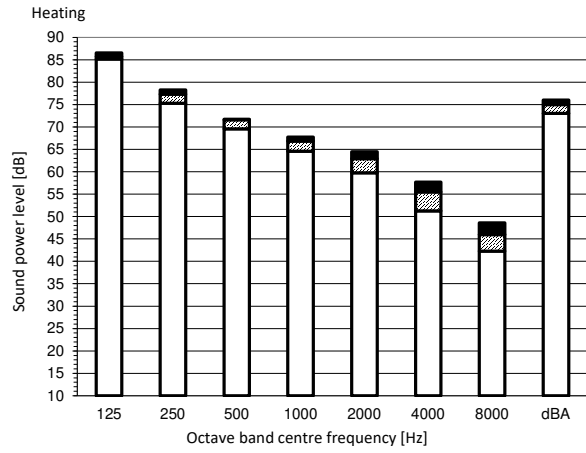
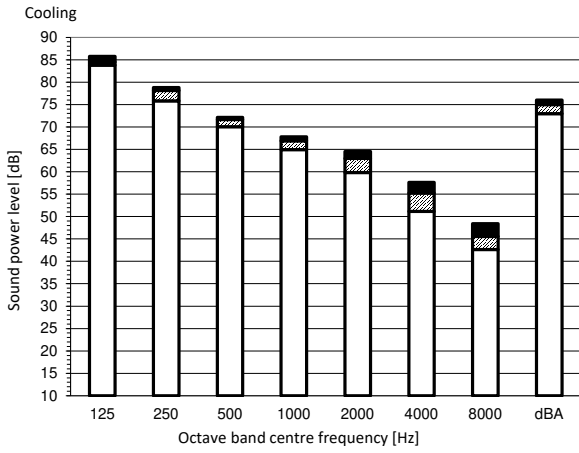

Notes

1. dBA = A-weighted sound power level (A scale according to IEC).
2. Reference acoustic power 0 dB = 10^{-6} W
3. Measured according to ISO 3744

4D140666

10 Sound data

10 - 2 Sound Pressure Spectrum

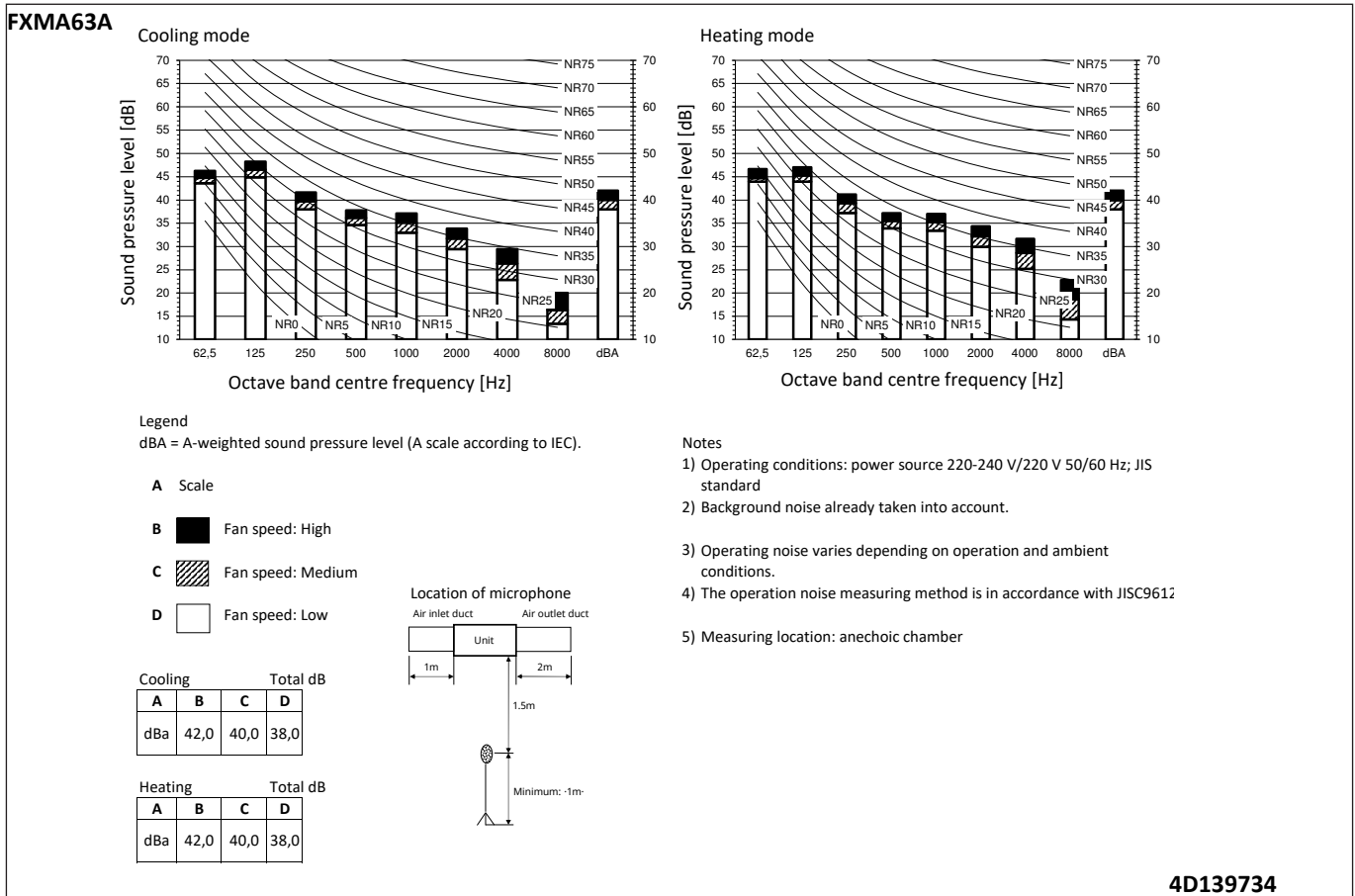
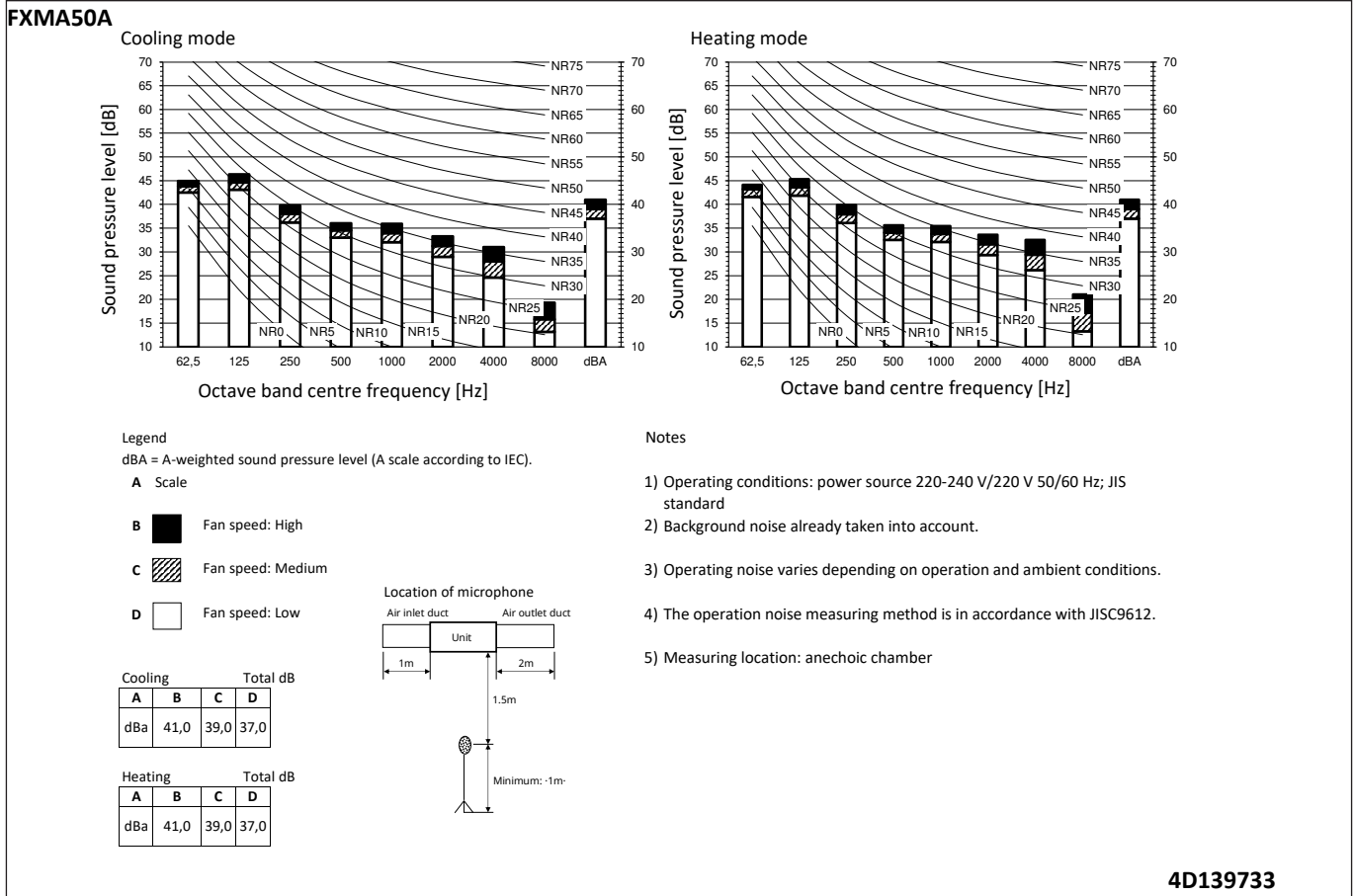

10 Sound data

10 - 2 Sound Pressure Spectrum

10

FXMA80A

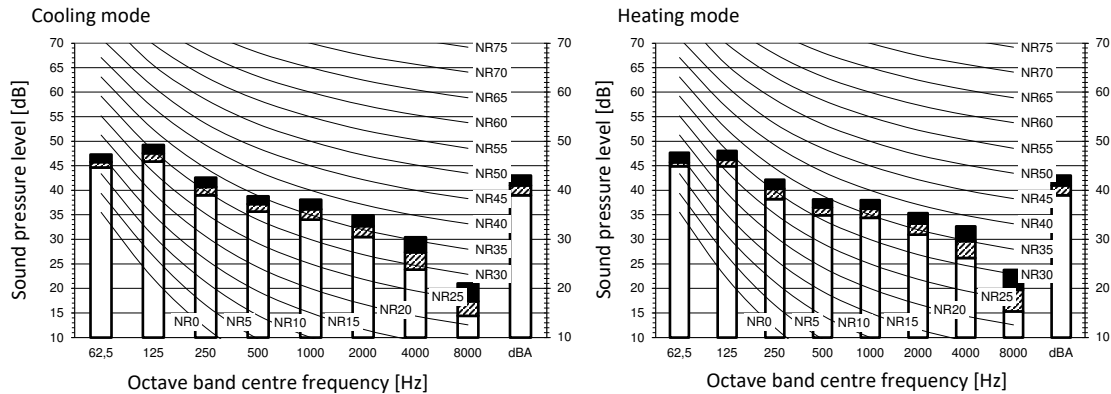

Legend
 dBA = A-weighted sound pressure level (A scale according to IEC).

- A** Scale
- B** Fan speed: High
 - C** Fan speed: Medium
 - D** Fan speed: Low

Cooling	Total dB			
A	B	C	D	
dBa	43,0	41,0	39,0	

Heating	Total dB			
A	B	C	D	
dBa	43,0	41,0	39,0	

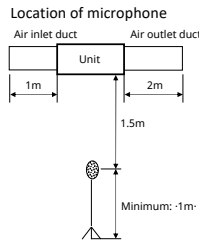

- Notes
- 1) Operating conditions: power source 220-240 V/220 V 50/60 Hz; JIS standard
 - 2) Background noise already taken into account.
 - 3) Operating noise varies depending on operation and ambient conditions.
 - 4) The operation noise measuring method is in accordance with JISC9612.
 - 5) Measuring location: anechoic chamber

4D139737

FXMA100A

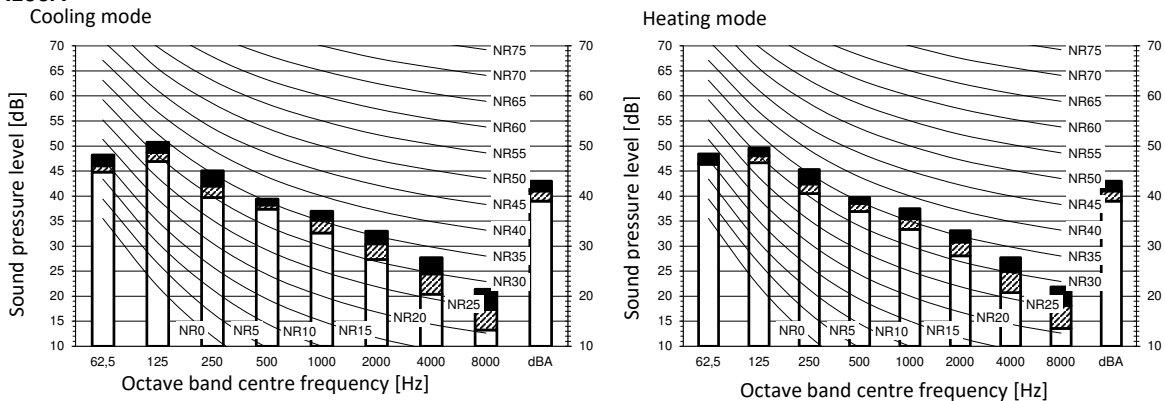

Legend
 dBA = A-weighted sound pressure level (A scale according to IEC).

- A** Scale
- B** Fan speed: High
 - C** Fan speed: Medium
 - D** Fan speed: Low

Cooling	Total dB			
A	B	C	D	
dBa	43,0	41,0	39,0	

Heating	Total dB			
A	B	C	D	
dBa	43,0	41,0	39,0	

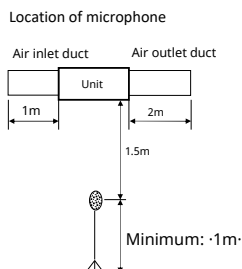

- Notes
- 1) Operating conditions: power source 220-240 V/220 V 50/60 Hz; JIS standard
 - 2) Background noise already taken into account.
 - 3) Operating noise varies depending on operation and ambient conditions.
 - 4) The operation noise measuring method is in accordance with JISC9612.
 - 5) Measuring location: anechoic chamber

4D139738

10 Sound data

10 - 2 Sound Pressure Spectrum

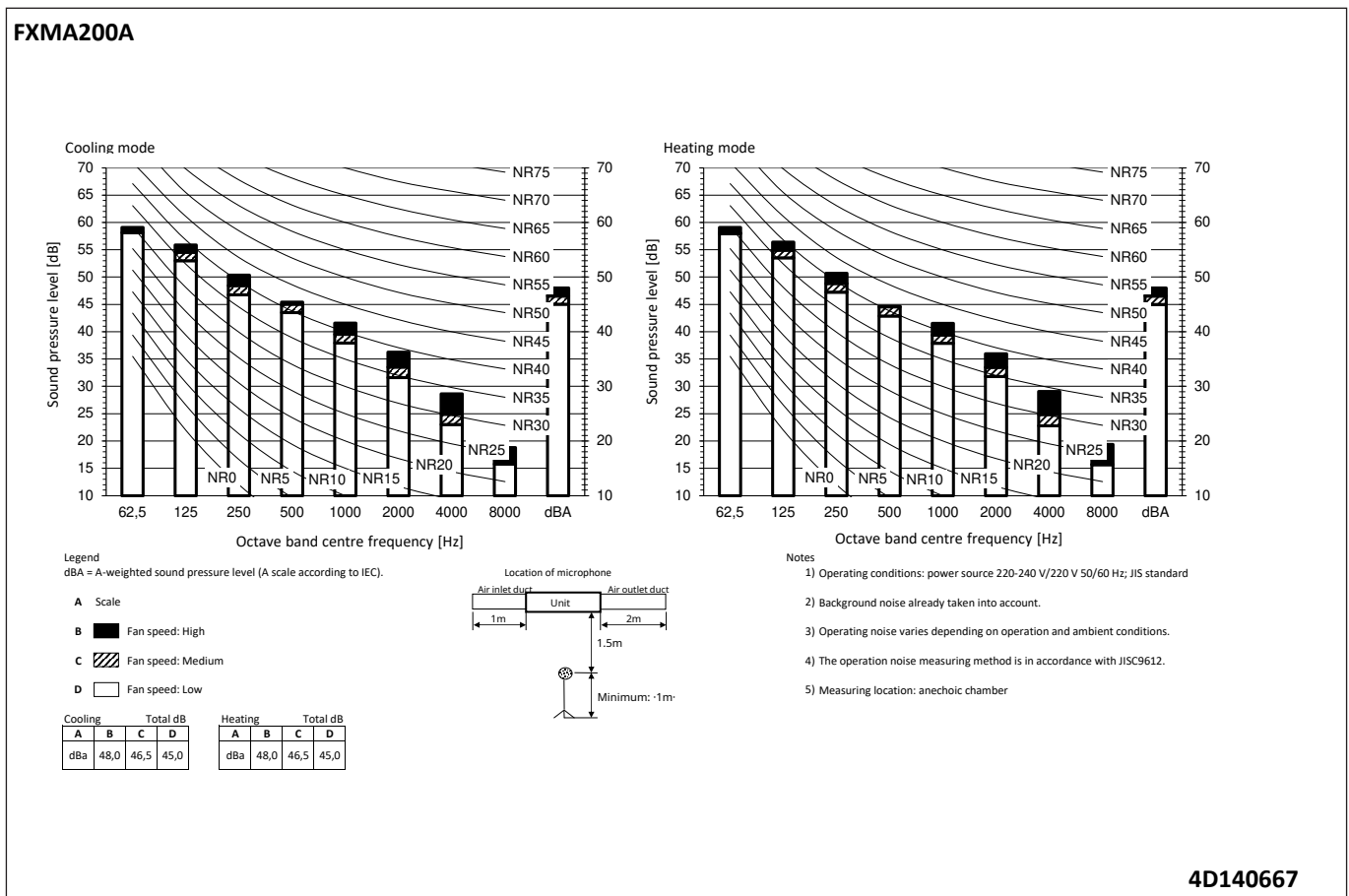
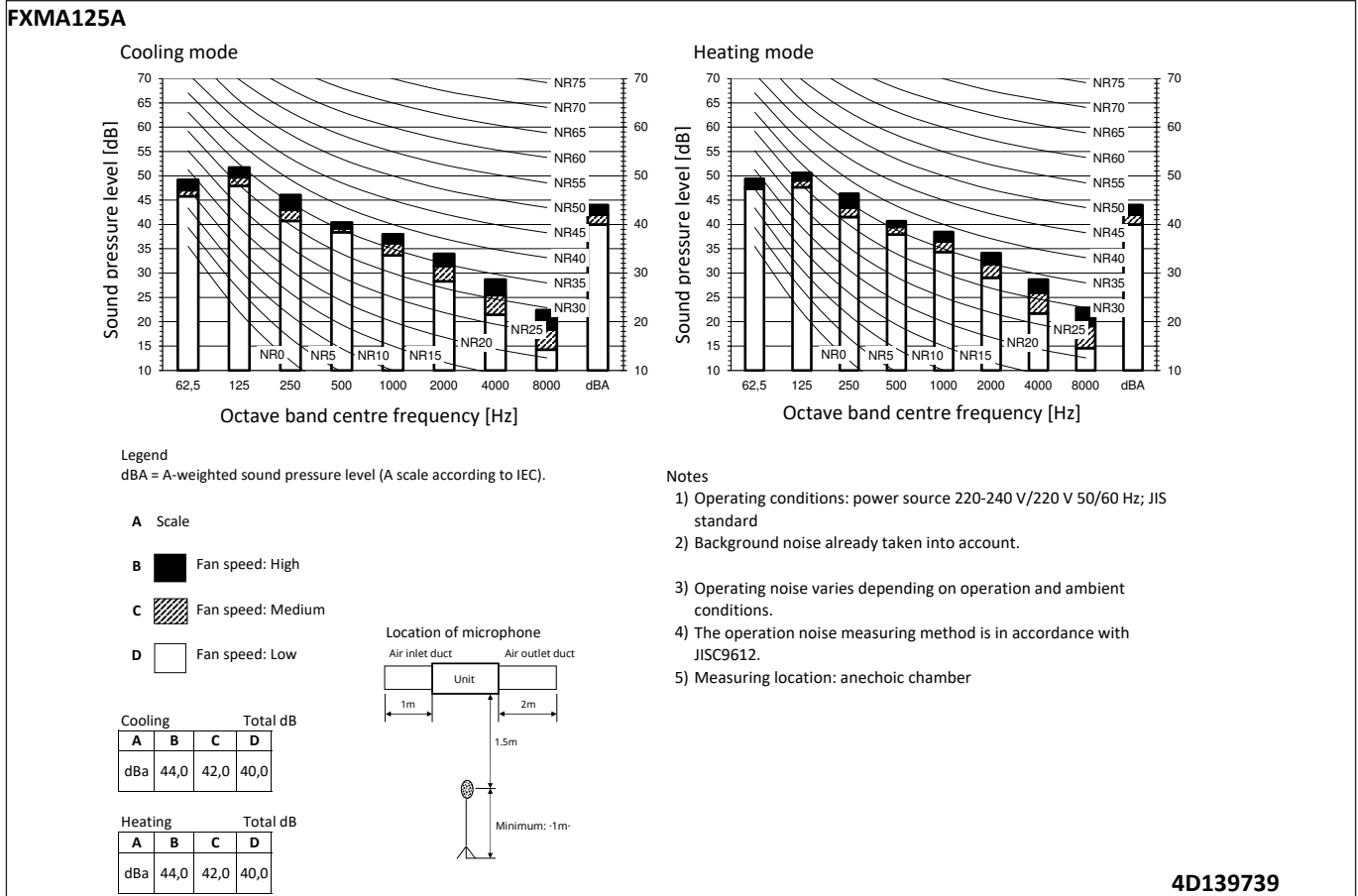

10 Sound data

10 - 2 Sound Pressure Spectrum

10

FXMA250A

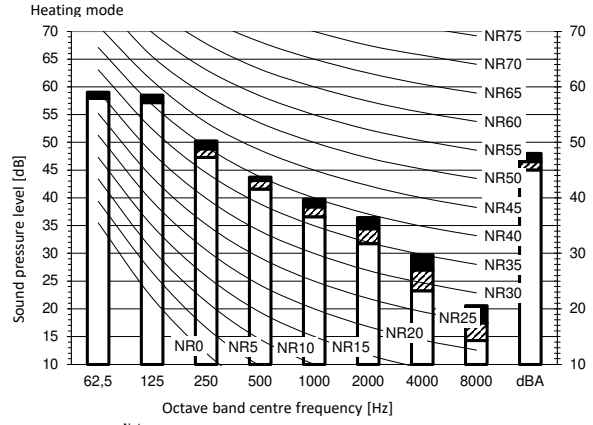
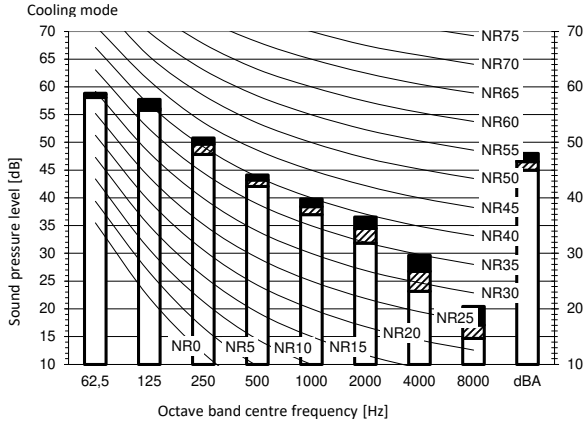

Legend
dBA = A-weighted sound pressure level (A scale according to IEC).

- A Scale
- B Fan speed: High
- C Fan speed: Medium
- D Fan speed: Low

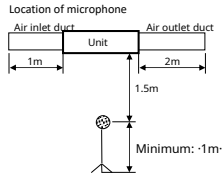

Cooling				Heating				
	A	B	C	D	A	B	C	D
Total dB	48,0	46,5	45,0		48,0	46,5	45,0	

Notes

- 1) Operating conditions: power source 220-240 V/220 V 50/60 Hz; JIS standard
- 2) Background noise already taken into account.
- 3) Operating noise varies depending on operation and ambient conditions.
- 4) The operation noise measuring method is in accordance with JISC9612.
- 5) Measuring location: anechoic chamber

4D140668

11 Fan characteristics

11 - 1 Fan Characteristics

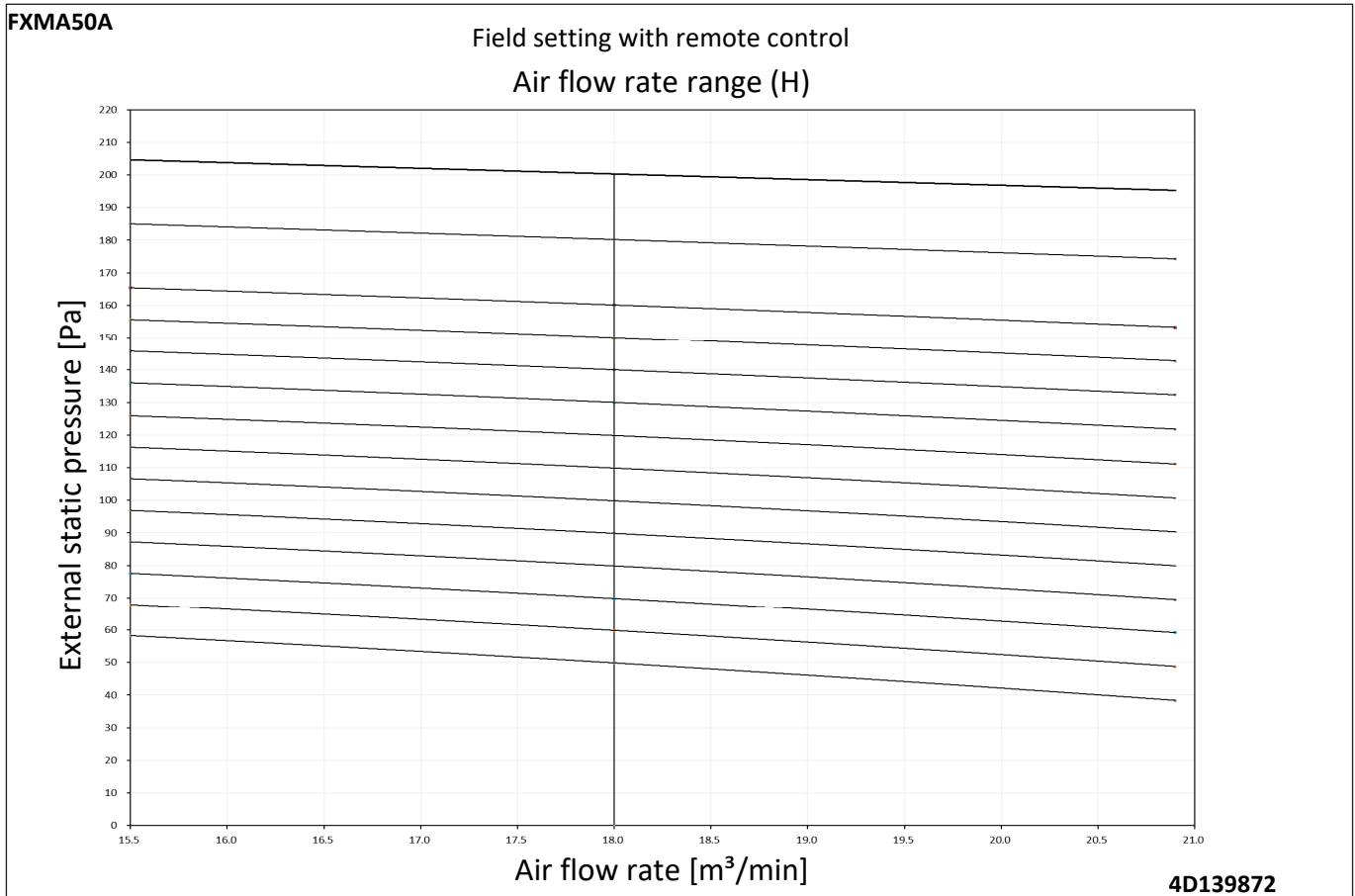
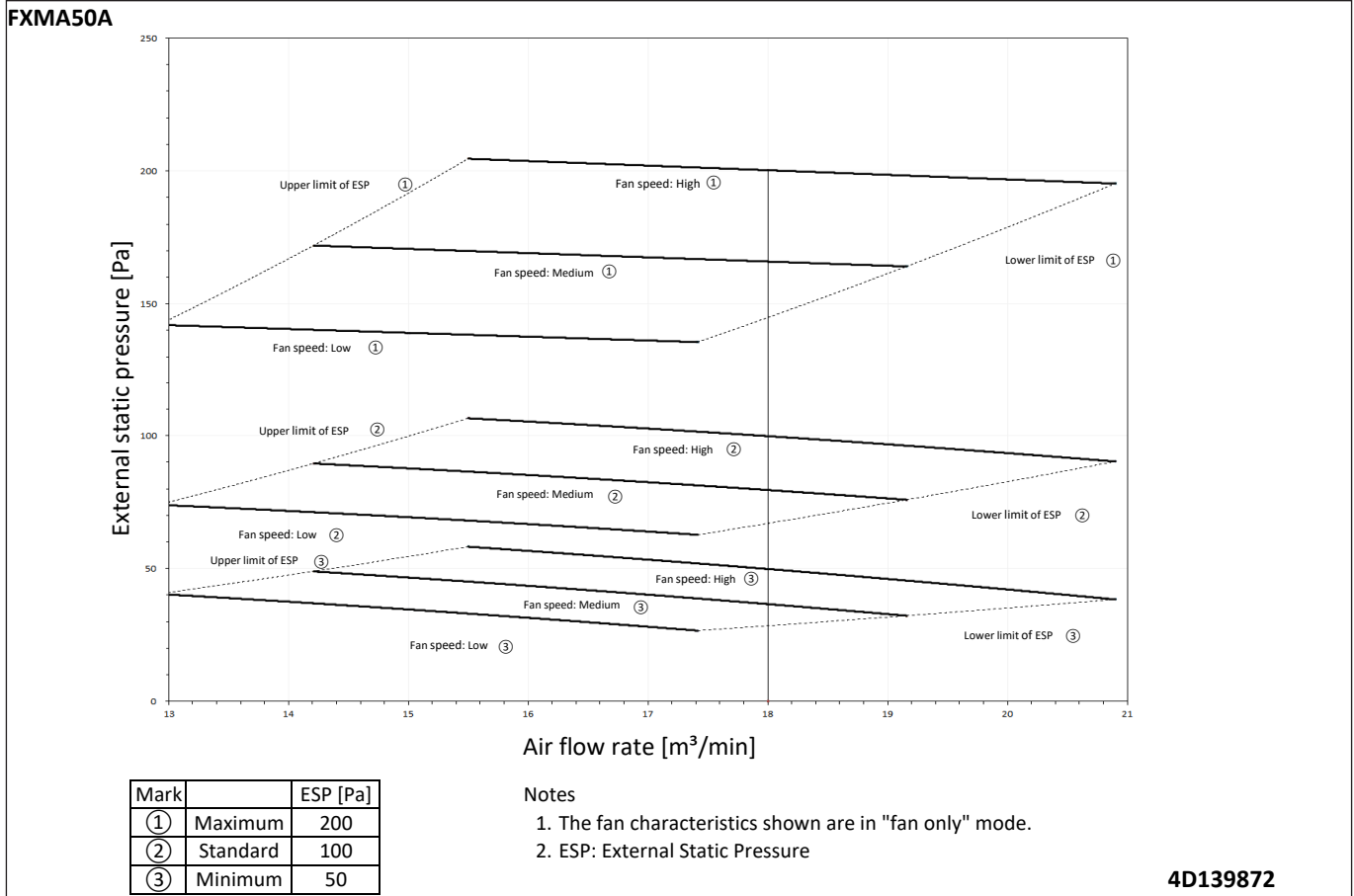

11 Fan characteristics

11 - 1 Fan Characteristics

11

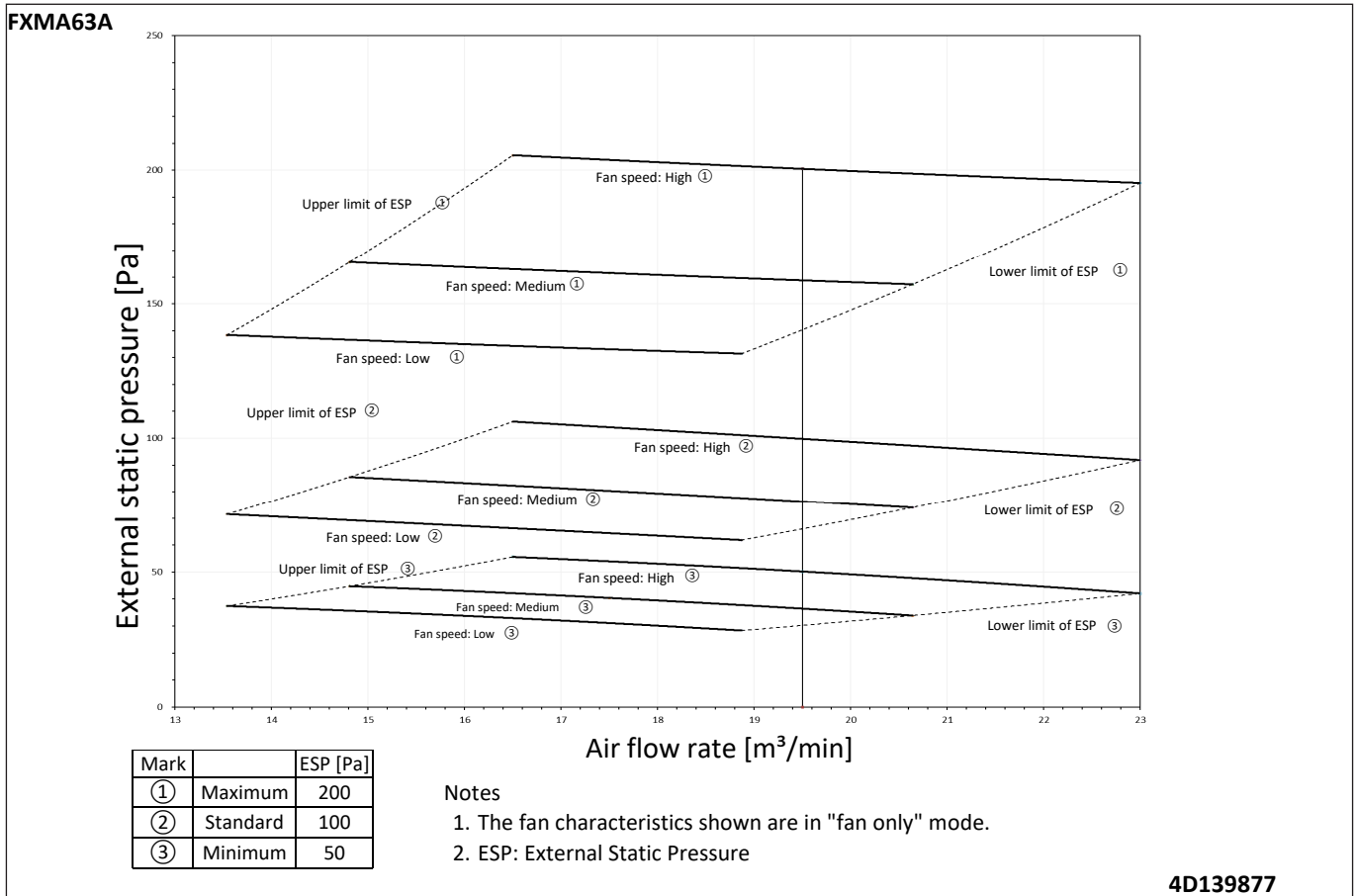
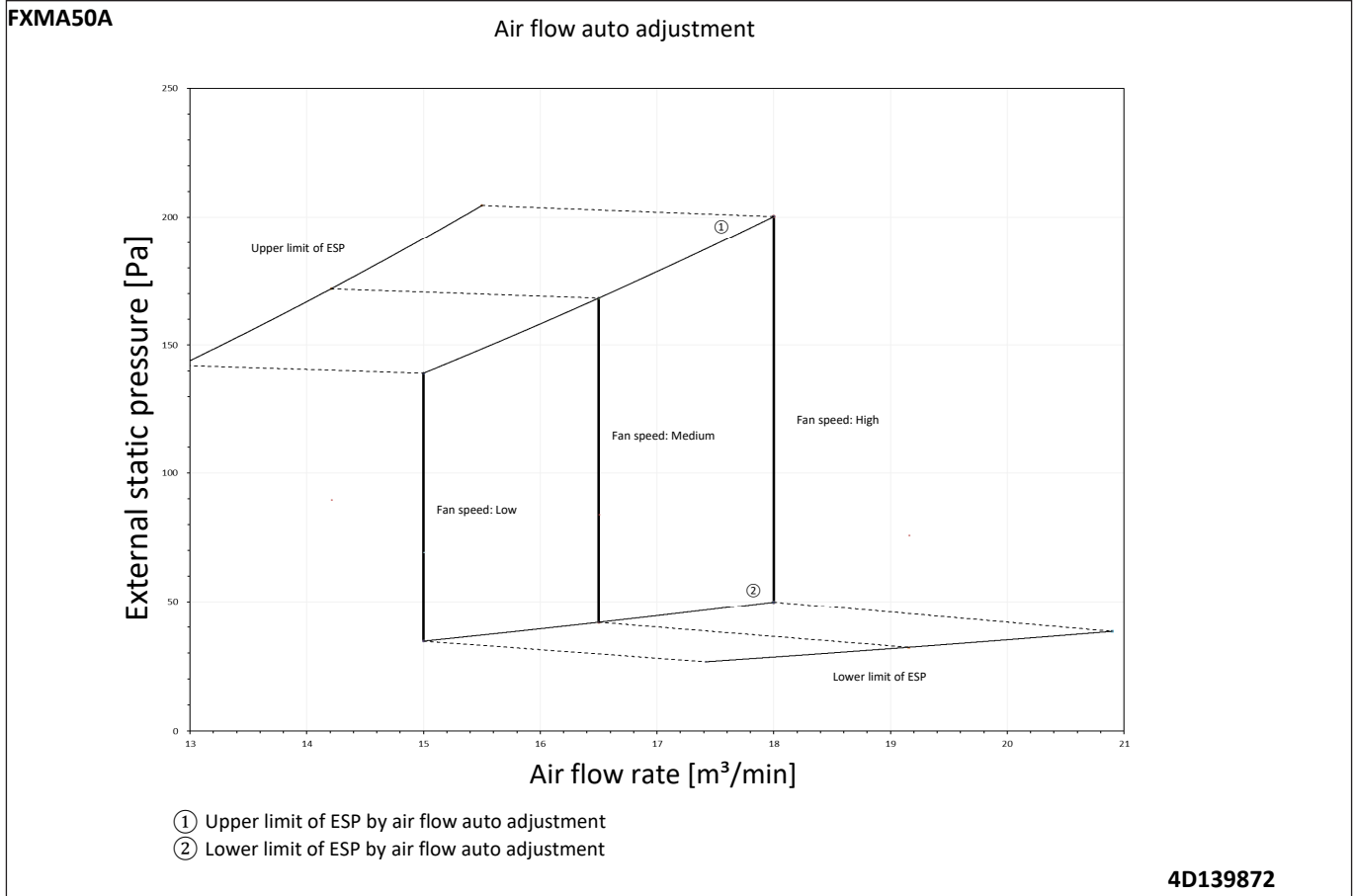

11 Fan characteristics

11 - 1 Fan Characteristics

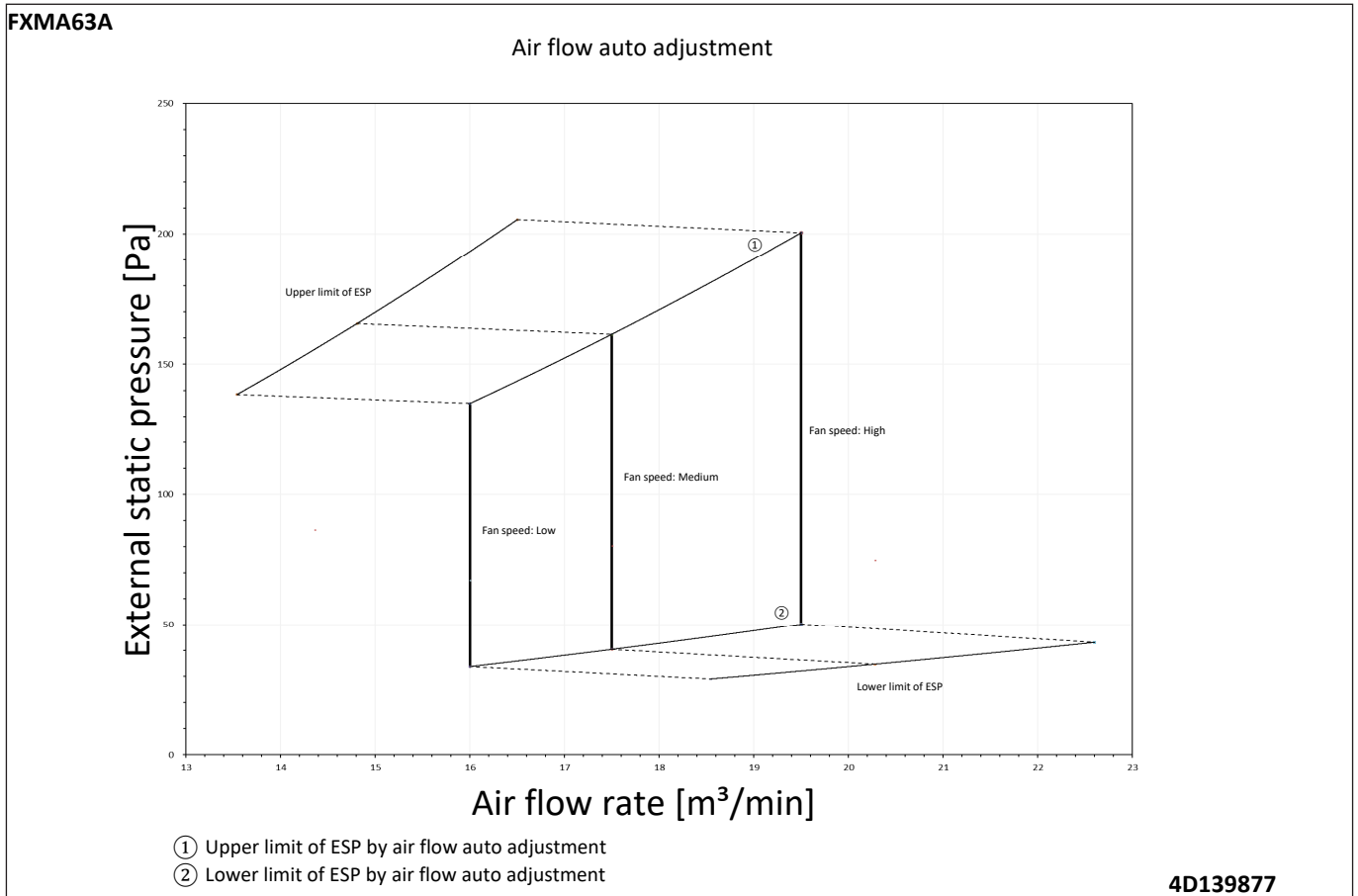
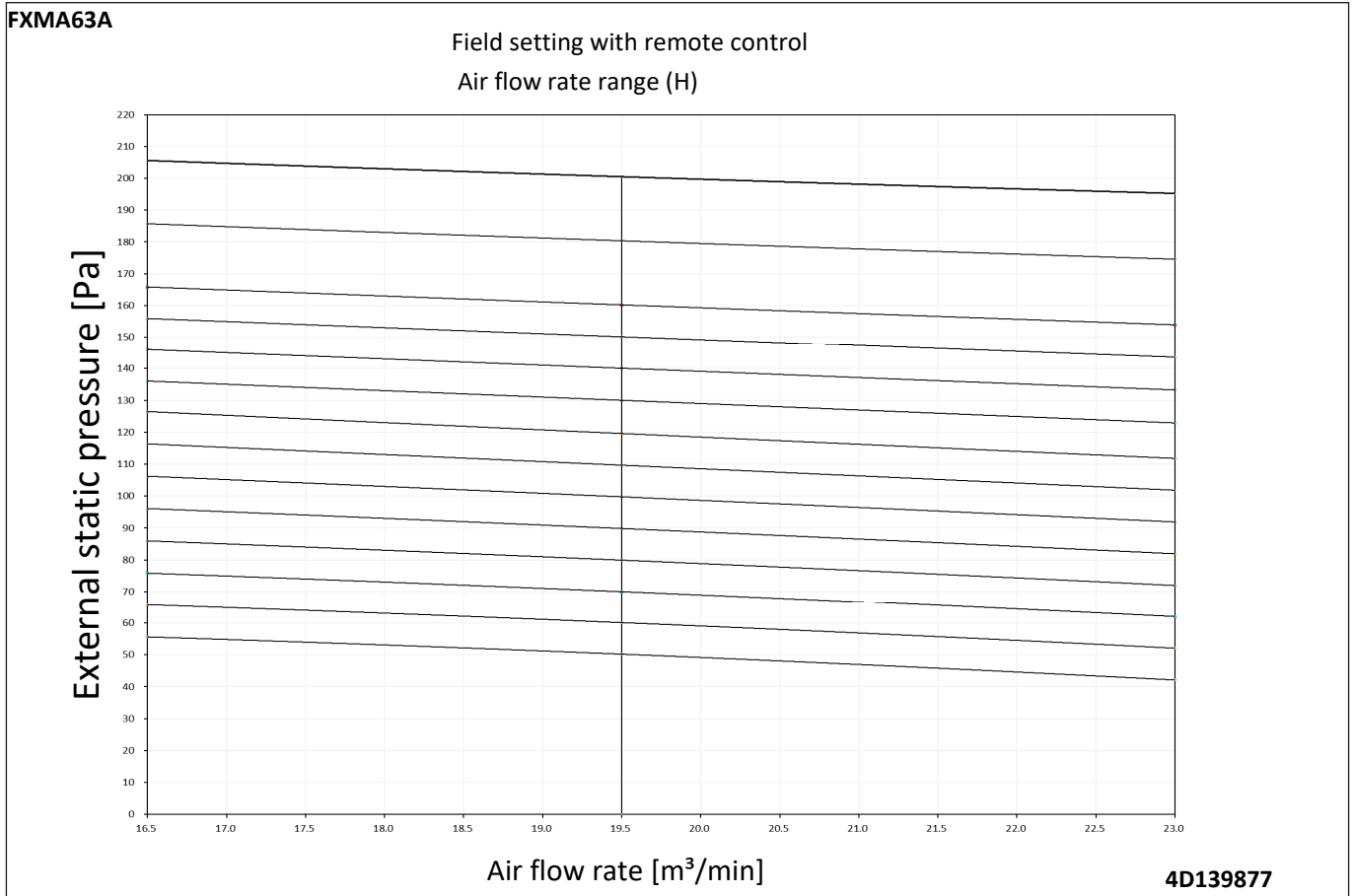

11 Fan characteristics

11 - 1 Fan Characteristics

11

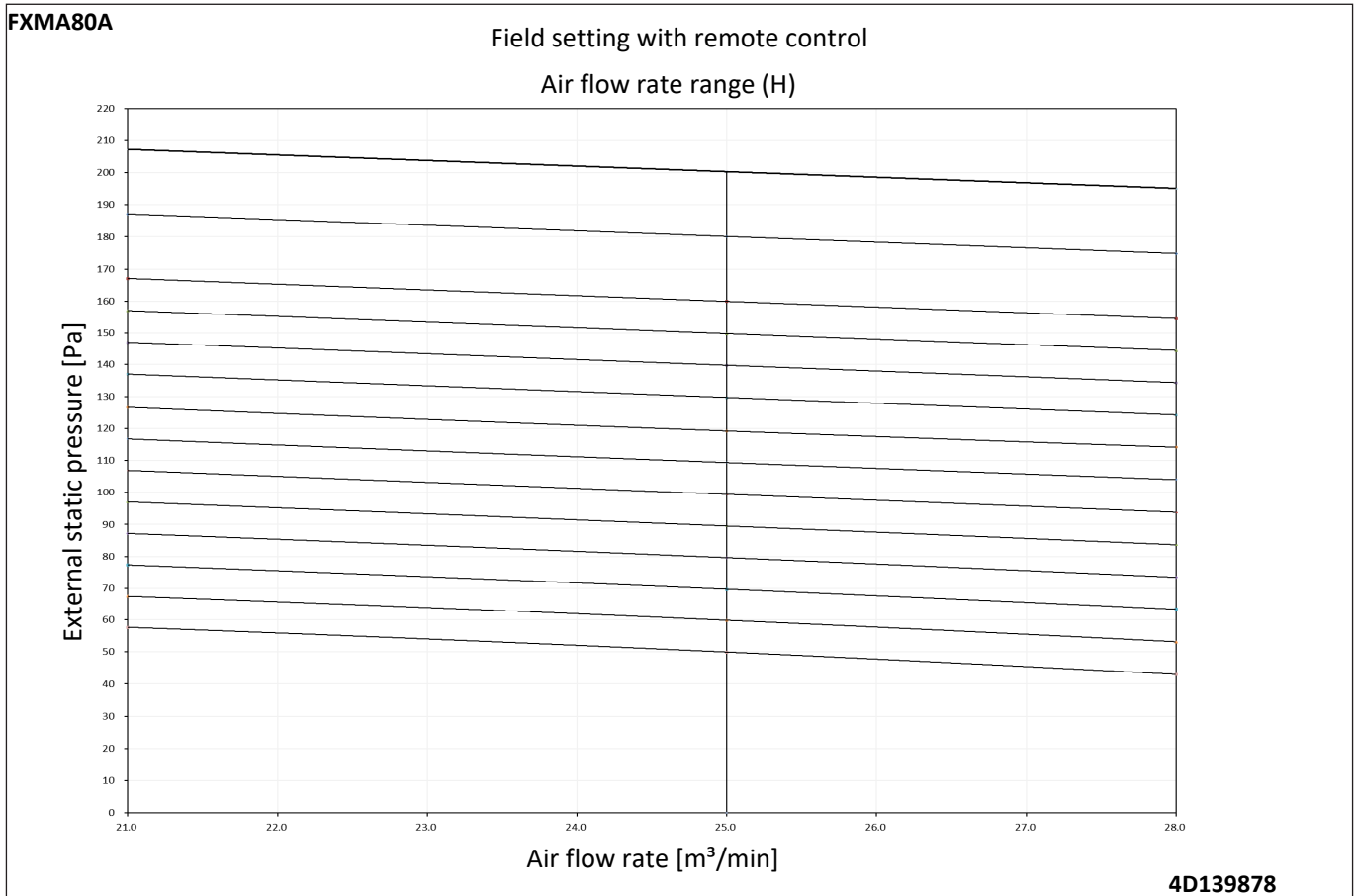
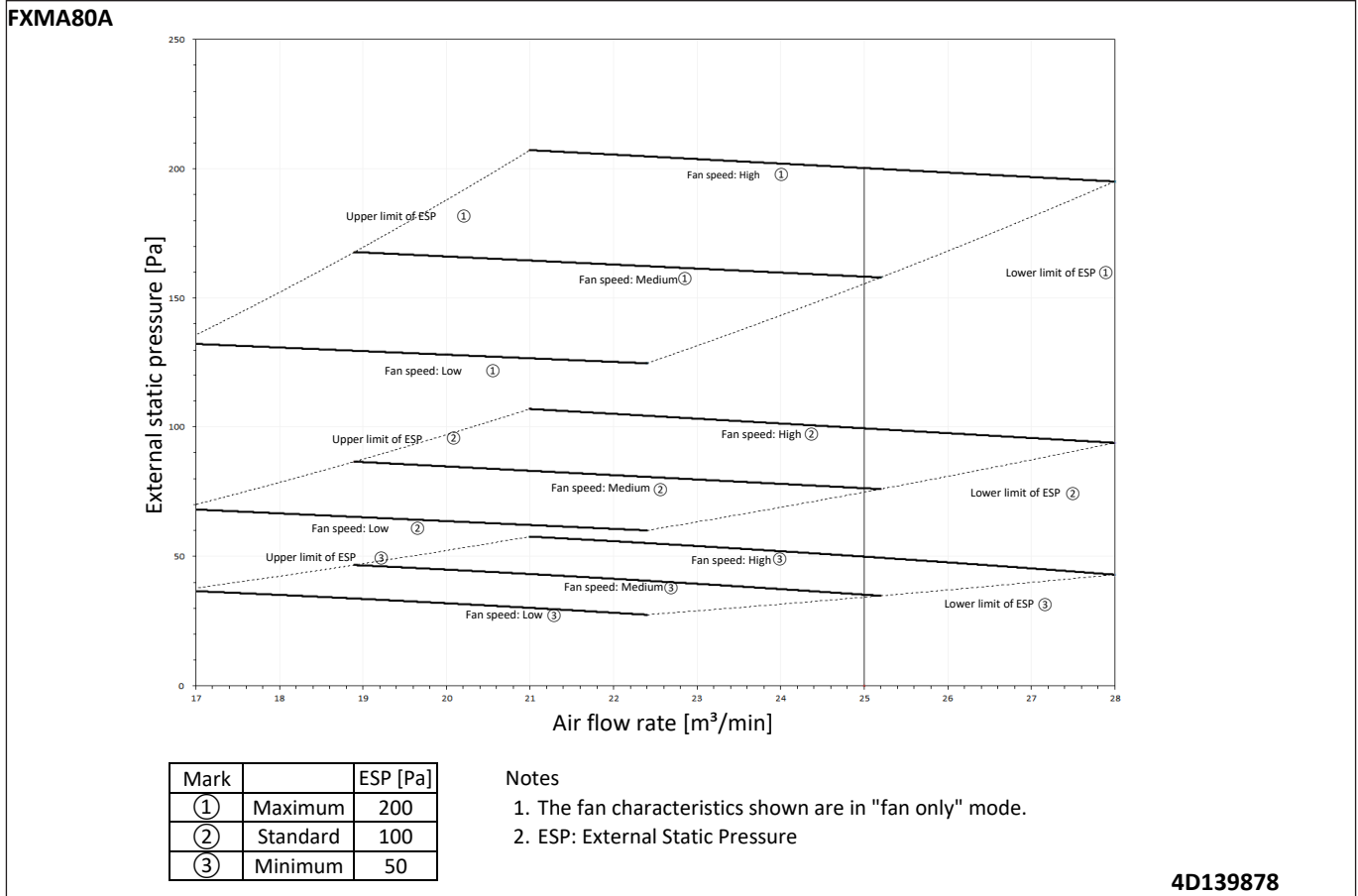

11 Fan characteristics

11 - 1 Fan Characteristics

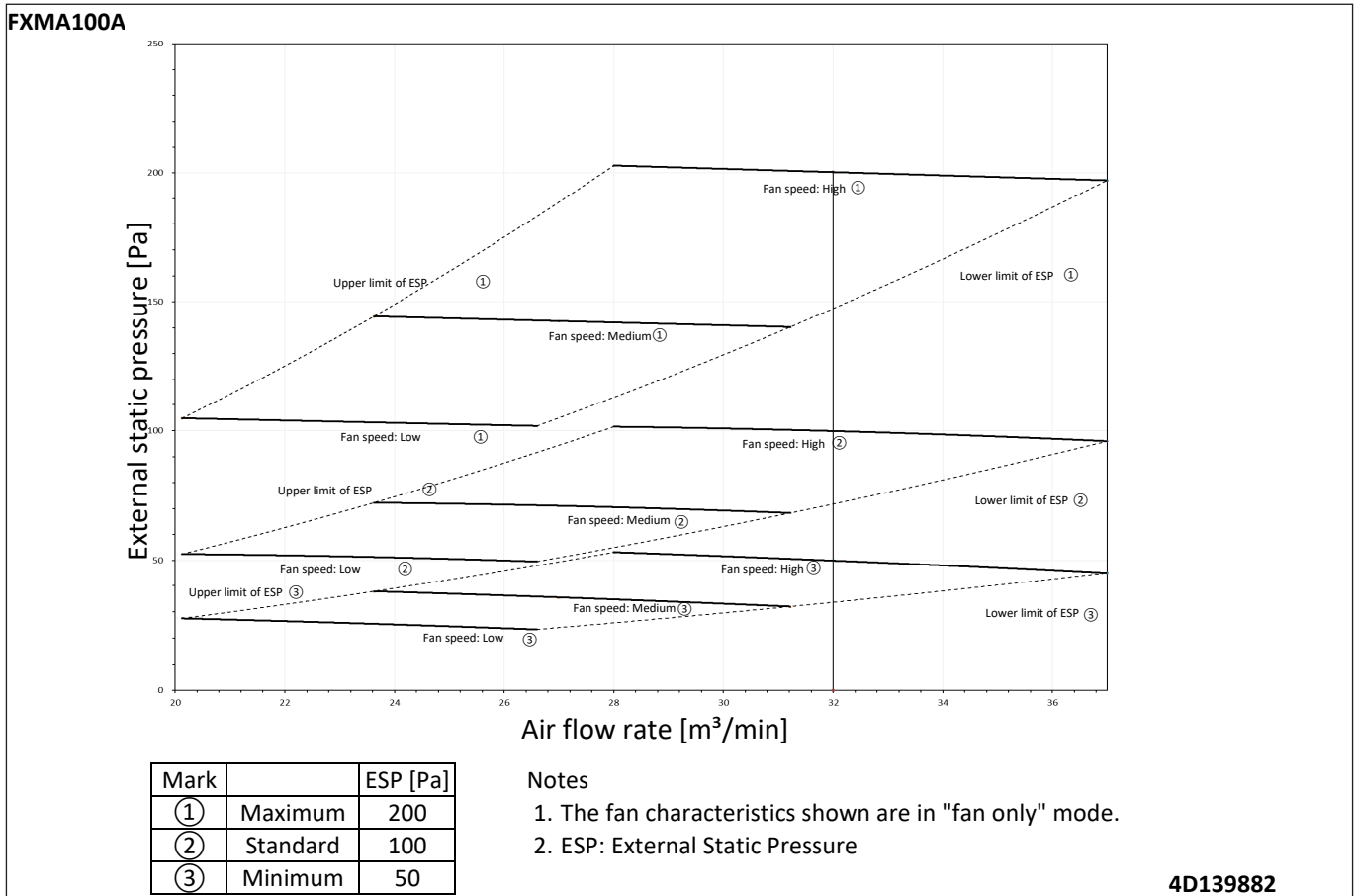
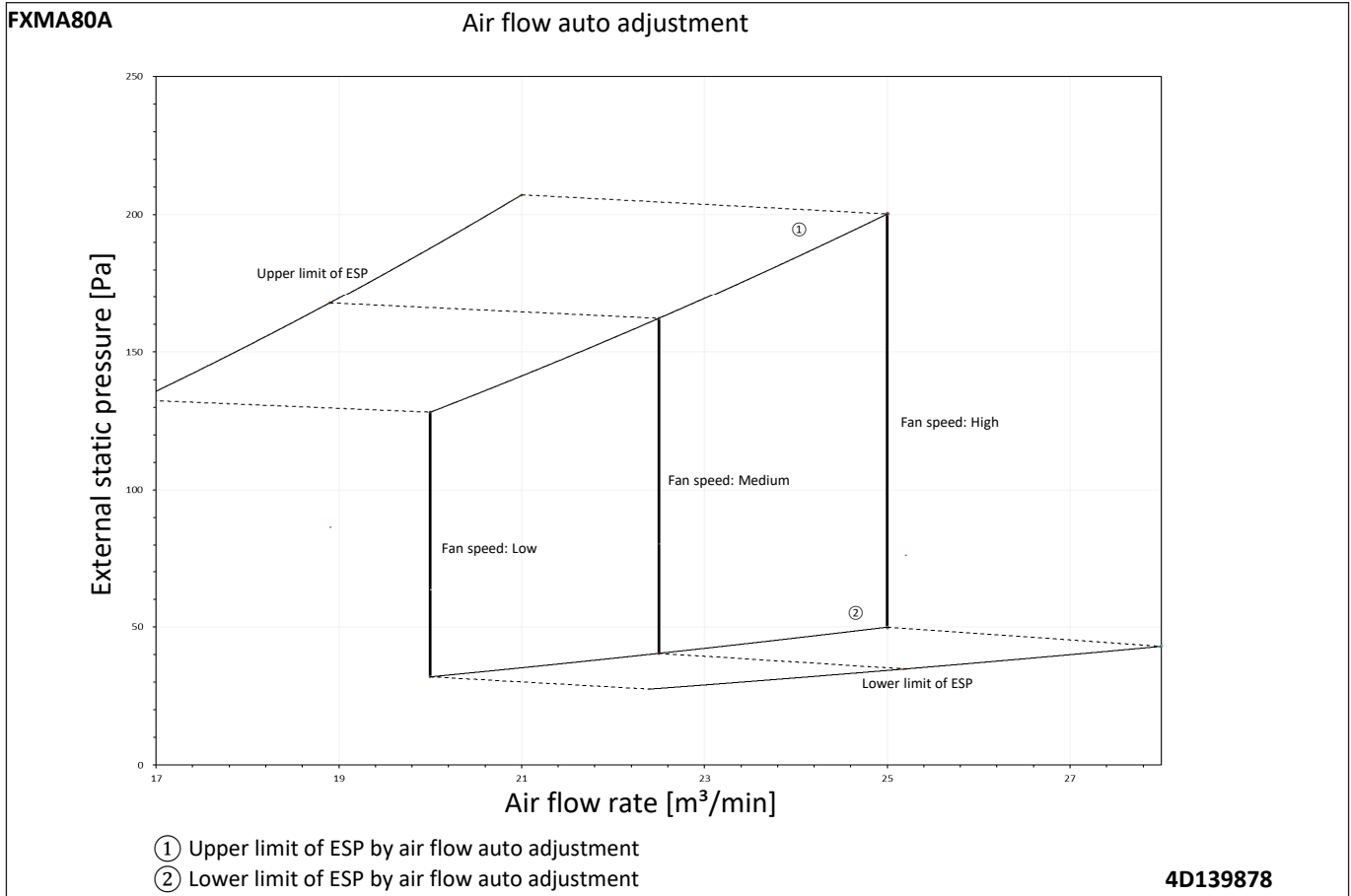

11 Fan characteristics

11 - 1 Fan Characteristics

11

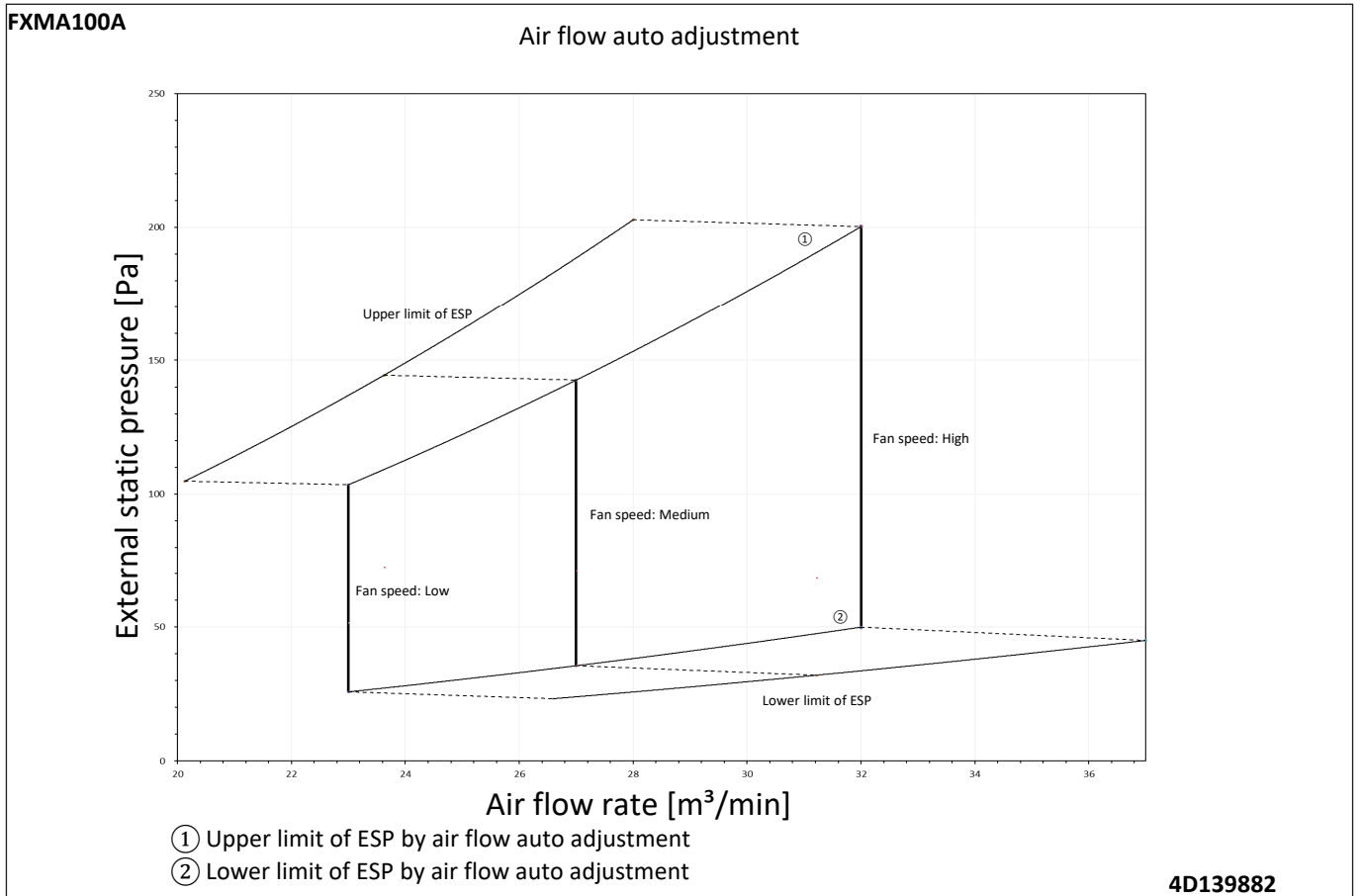
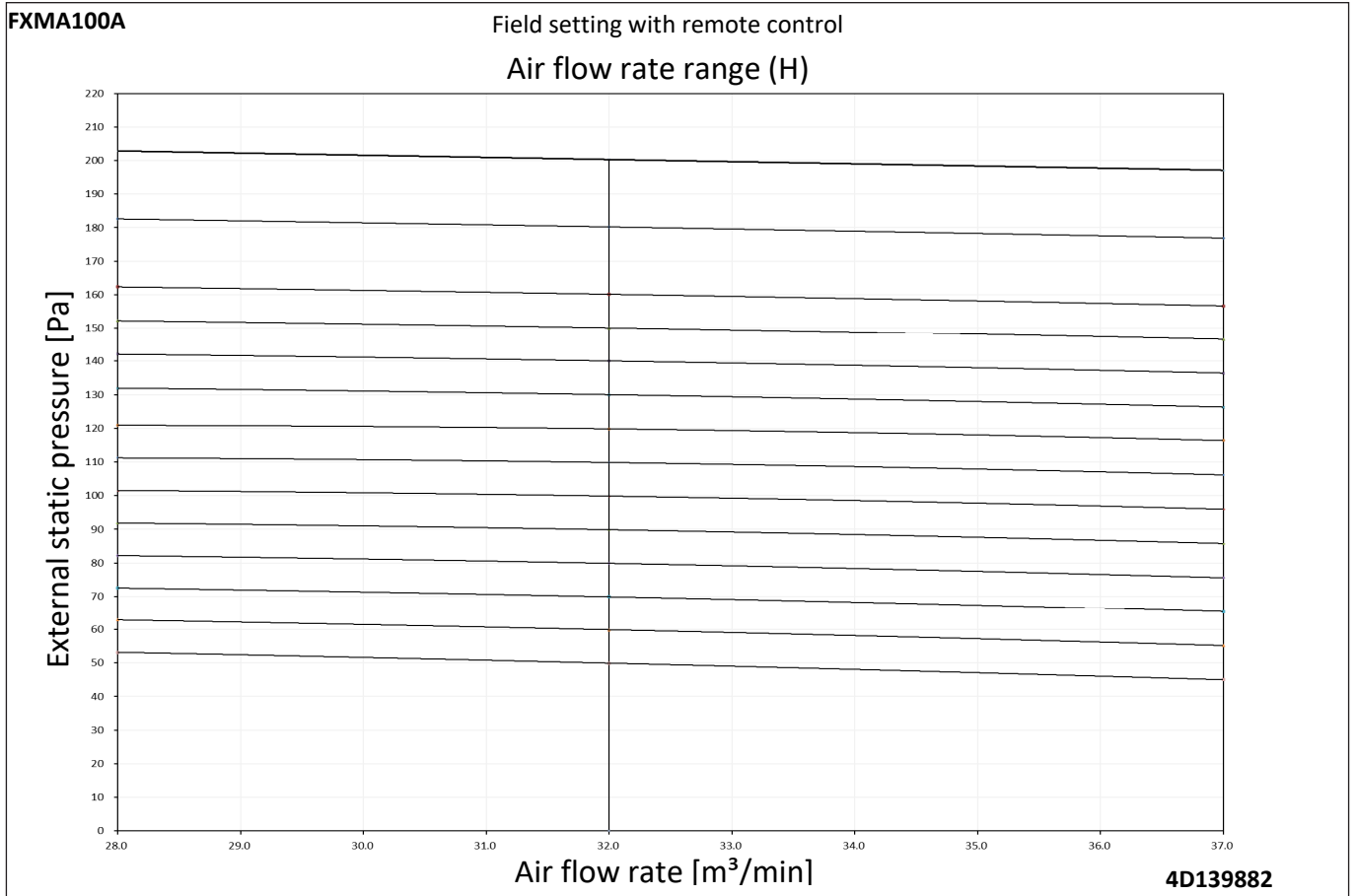

11 Fan characteristics

11 - 1 Fan Characteristics

FXMA125A

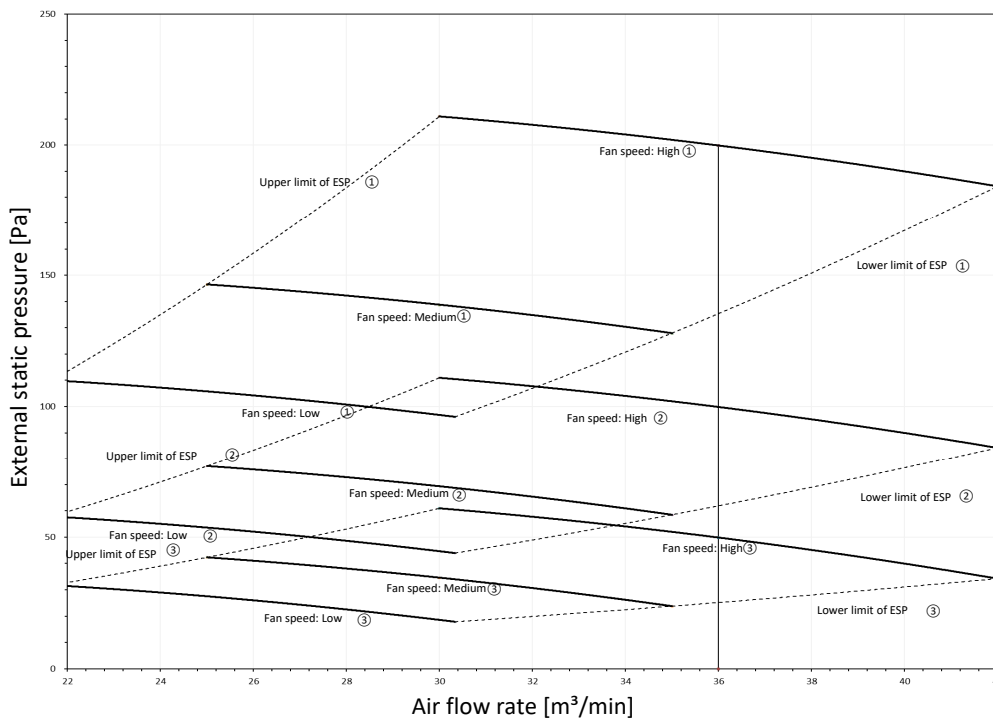

Mark		ESP [Pa]
①	Maximum	200
②	Standard	100
③	Minimum	50

Notes

- 1. The fan characteristics shown are in "fan only" mode.
- 2. ESP: External Static Pressure

4D139884

FXMA125A

Field setting with remote control

Air flow rate range (H)

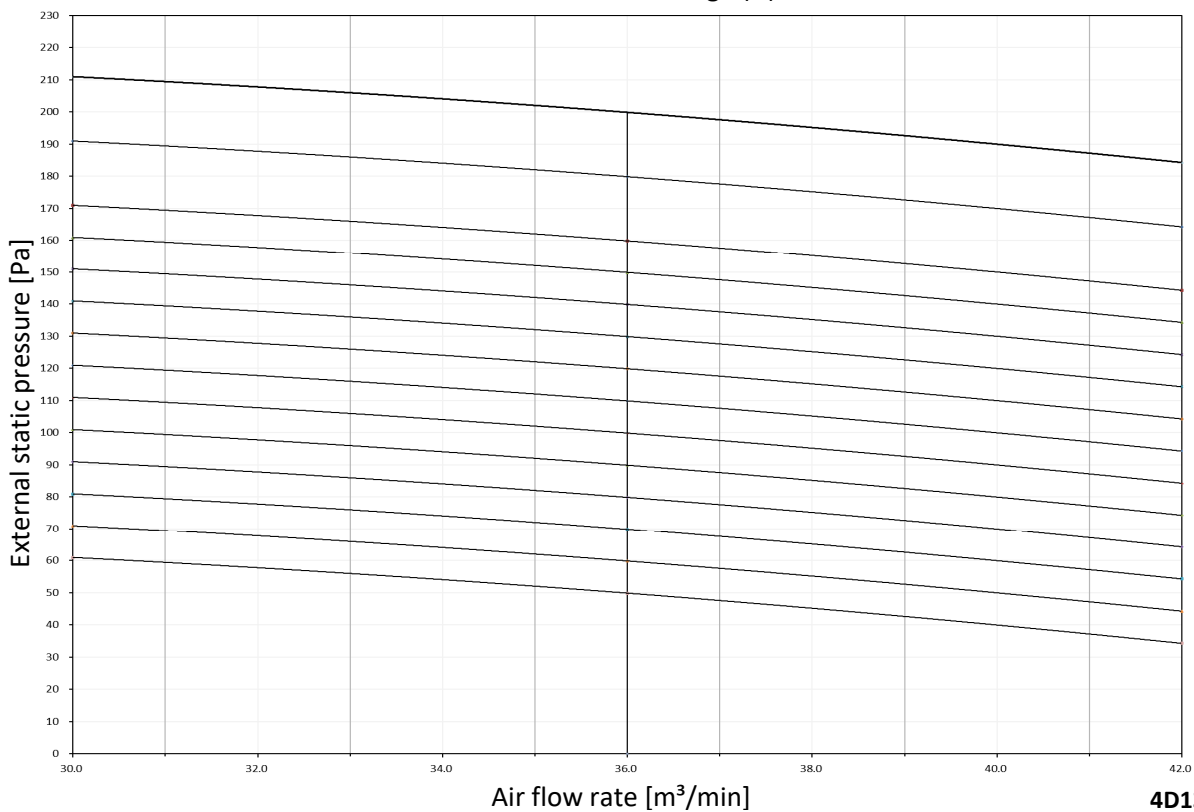

4D139884

11 Fan characteristics

11 - 1 Fan Characteristics

11

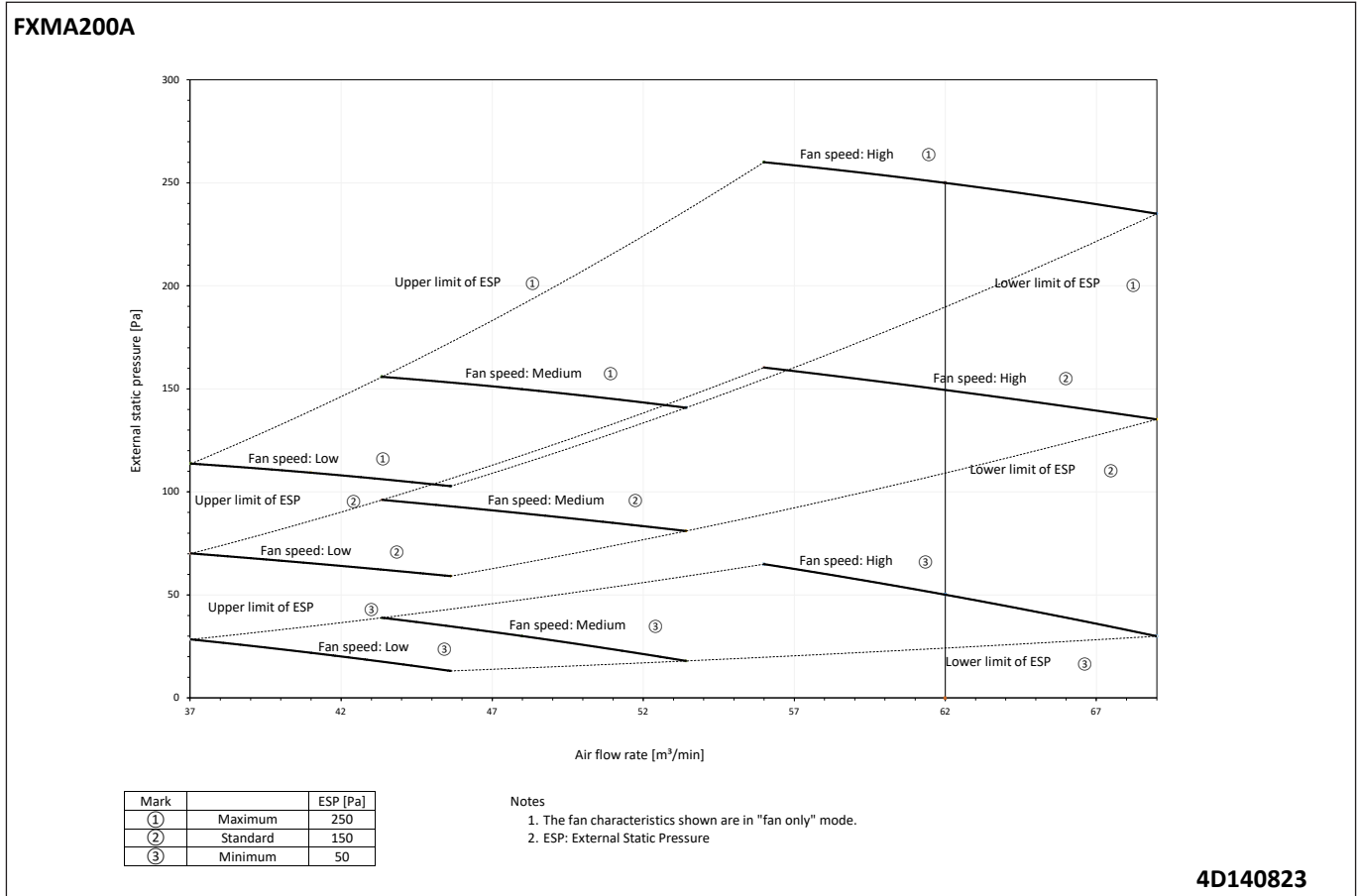
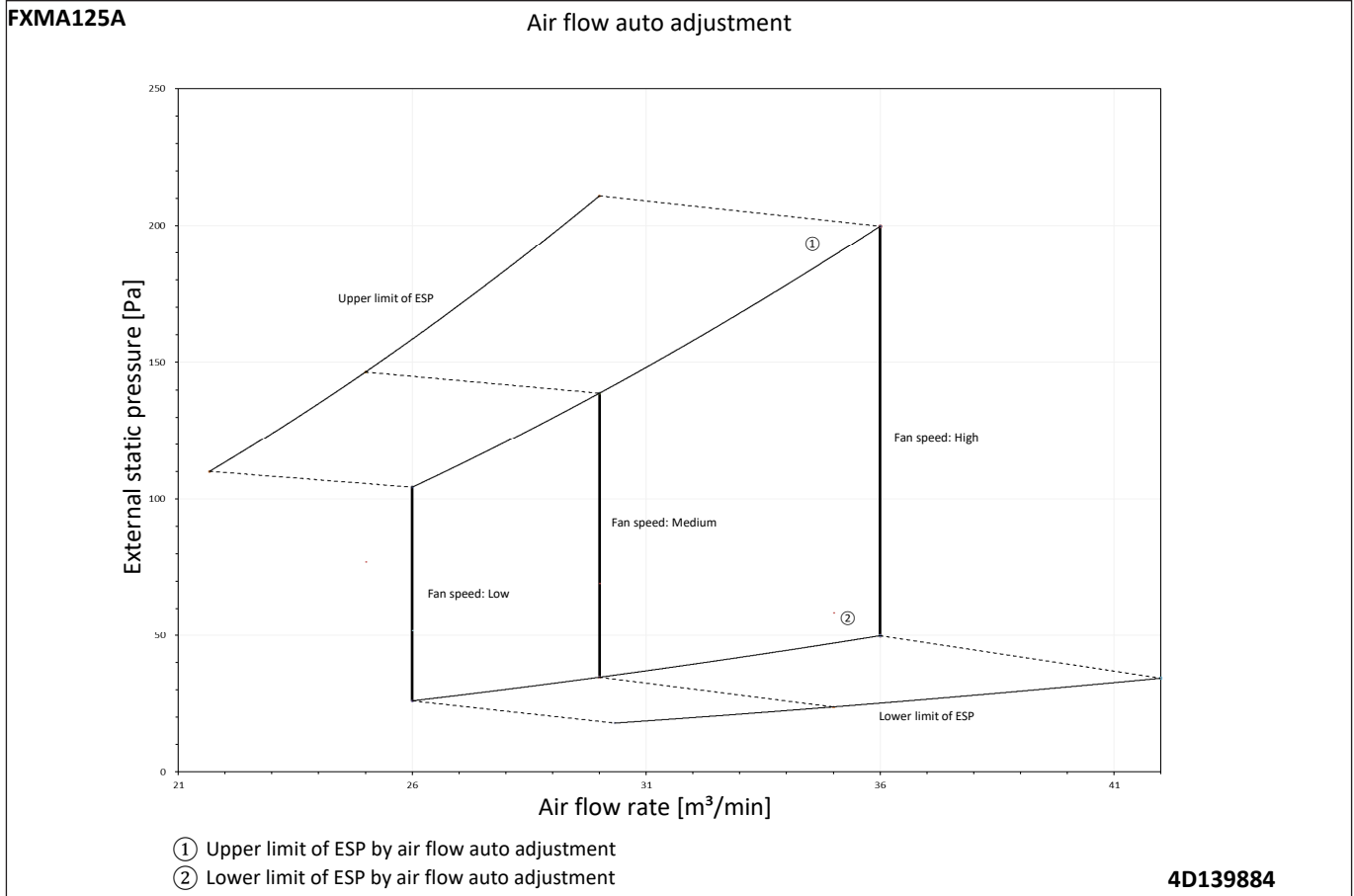

11 Fan characteristics

11 - 1 Fan Characteristics

FXMA200A

Field setting with remote control
Air flow rate range (H)

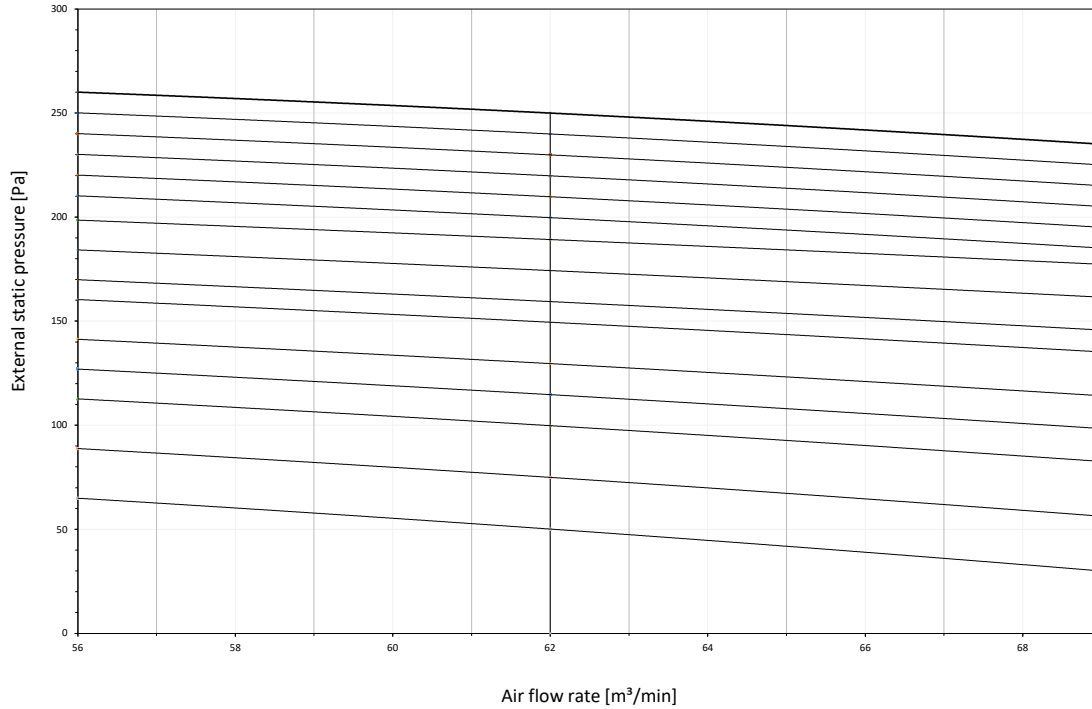

4D140823

FXMA200A

Air flow auto adjustment

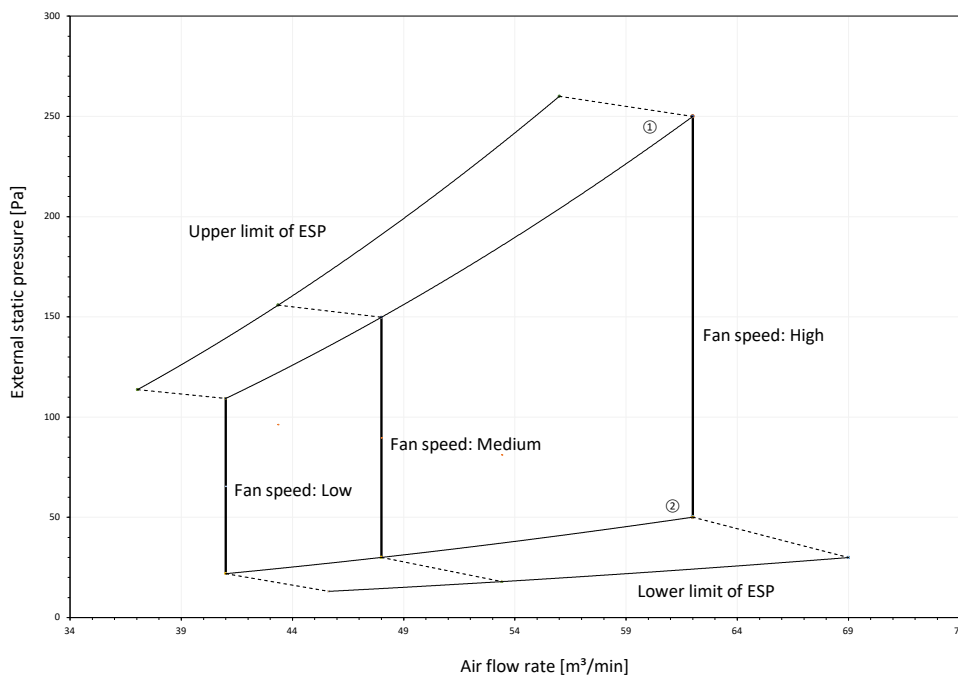

- ① Upper limit of ESP by air flow auto adjustment
- ② Lower limit of ESP by air flow auto adjustment

4D140823

11 Fan characteristics

11 - 1 Fan Characteristics

11

FXMA250A

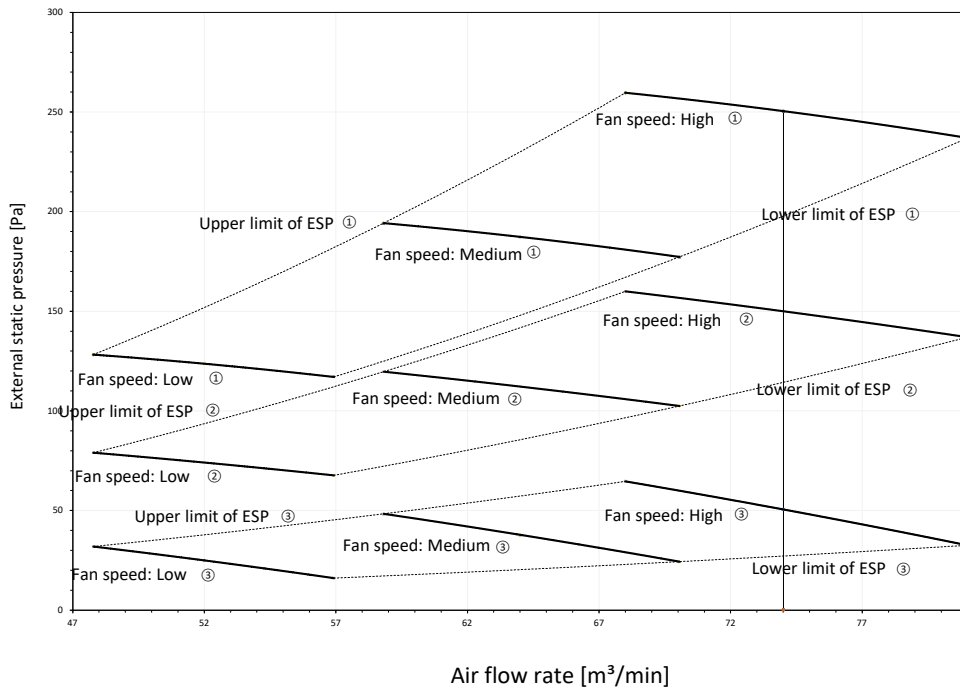

Mark		ESP [Pa]
①	Maximum	250
②	Standard	150
③	Minimum	50

Notes

1. The fan characteristics shown are in "fan only" mode.
2. ESP: External Static Pressure

4D140824

FXMA250A

Field setting with remote control
Air flow rate range (H)

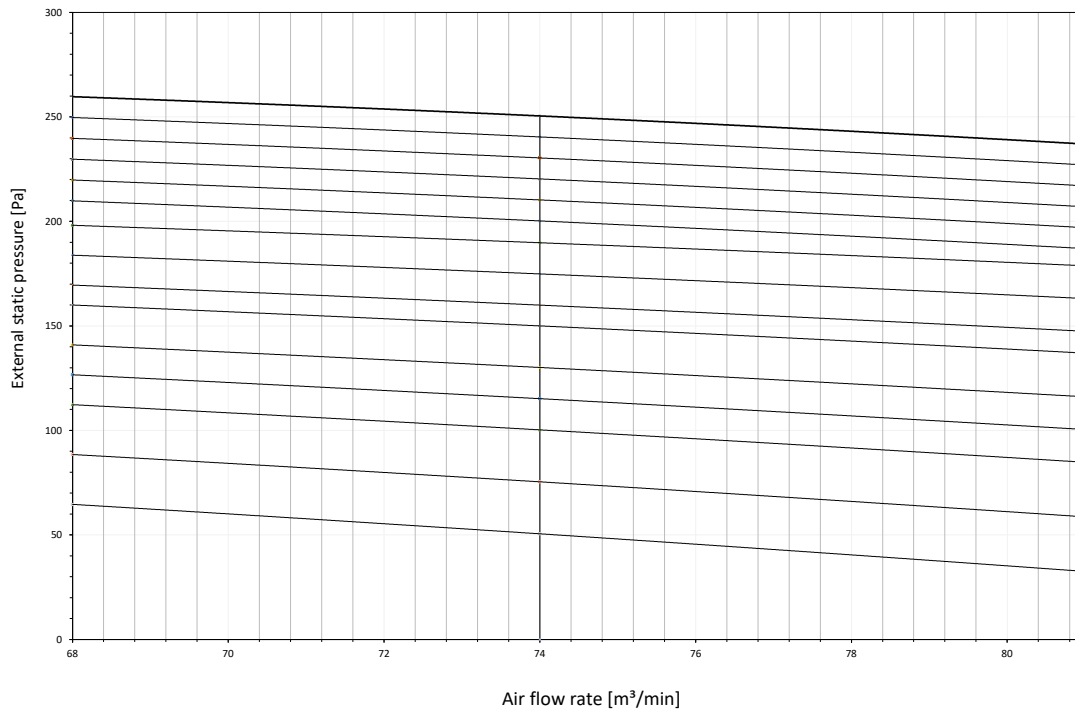

4D140824

11 Fan characteristics

11 - 1 Fan Characteristics

FXMA250A

Air flow auto adjustment

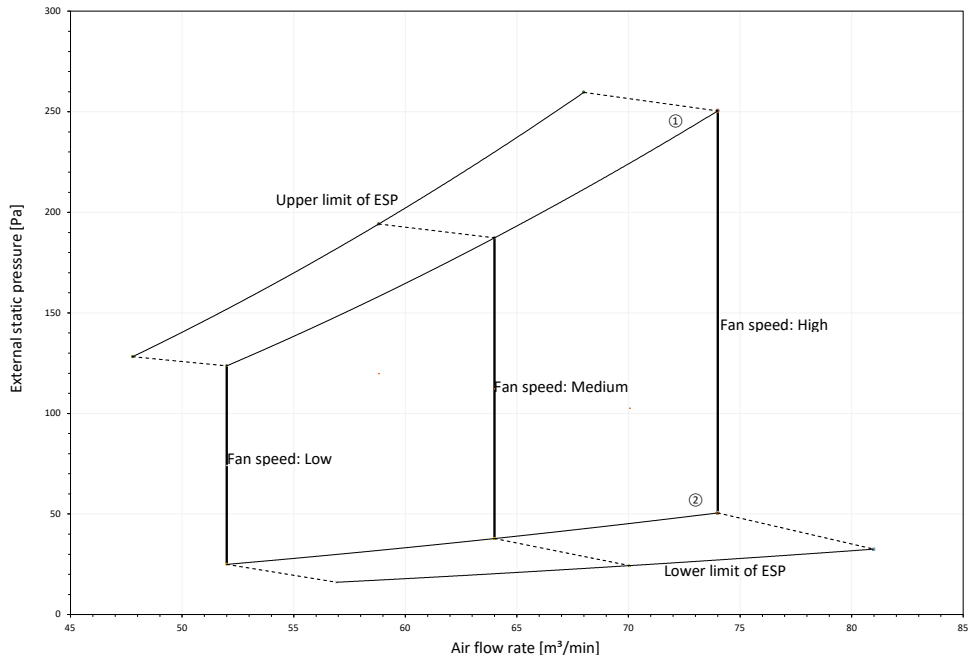

- ① Upper limit of ESP by air flow auto adjustment
- ② Lower limit of ESP by air flow auto adjustment

4D140824

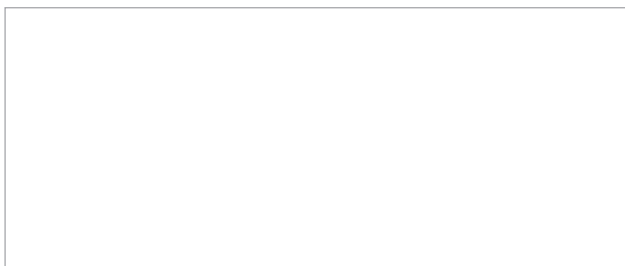

EEEDEN22

05/2022



The present publication is drawn up by way of information only and does not constitute an offer binding upon Daikin Europe N.V. / Daikin Central Europe HandelsGmbH. Daikin Europe N.V. / Daikin Central Europe HandelsGmbH have compiled the content of this publication to the best of their knowledge. No express or implied warranty is given for the completeness, accuracy, reliability or fitness for particular purpose of its content and the products and services presented therein. Specifications are subject to change without prior notice. Daikin Europe N.V. / Daikin Central Europe HandelsGmbH explicitly rejects any liability for any direct or indirect damage, in the broadest sense, arising from or related to the use and/or interpretation of this publication. All content is copyrighted by Daikin Europe N.V.